

# PTZ Optics 12X-USB



## User Manual

V1.3

(English)

Rev 1.3 12/15



## Preface

Thank you for using the USB 3.0 HD Video Conferencing Camera. This manual introduces the function, installation and operation of the HD camera. Prior to installation and usage, please read the manual thoroughly.

**Note: Minimum USB 3.0 System Requirements:** i3 Quad-Core  
(*Recommended: i5 Quad Core or better*)

## Precautions

This product can only be used in the specified conditions in order to avoid any damage to the camera:

- Don't subject the camera to rain or moisture.
- Don't remove the cover. Removal of the cover may result in an electric shock. In case of abnormal operation, contact the manufacturer.
- Never operate outside of the specified operating temperature range, humidity, or with any other power supply than the one originally provided with the camera.
- Please use a soft dry cloth to clean the camera. If the camera is very dirty, clean it with diluted neutral detergent; do not use any type of solvents, which may damage the surface.

## Note

This is an FCC Class A Digital device. As such, unintentional electromagnetic radiation may affect the image quality of TV in a home environment.

## Table of Contents

1	Supplied Accessories .....	1
2	Notes .....	1
3	Quick Start .....	2
4	Features .....	4
5	Product Specifications .....	5
6	Main Unit .....	7
7	IR Remote Controller Explanation .....	8
8	Using the IR Remote Controller .....	10
9	RS-232 Interface .....	13
10	Serial Communication Control & Command Listings .....	14
11	Menu Setting .....	27
12	Network Connection .....	32
13	Maintenance and Trouble Shooting .....	55

## Supplied Accessories

When you unpack your camera, check that all the supplied accessories are included:

- Camera ..... 1
- AC Power Adaptor ..... 1
- Power Cord..... 1
- USB 3.0 AB Cable ..... 1
- RS232 Cable..... 1
- IR Remote Controller ..... 1
- This User Manual ..... 1

## Notes

### ● Electrical Safety

Installation and operation must be in accordance with national and local electric safety standards. Do not use any power supply other than the one originally supplied with this camera.

### ● Polarity of power supply

The power supply output for this product is 12VDC with a maximum current supply of 2A. Polarity of the power supply plug is critical and is as follows.



### ● Handling

- Avoid any stress, vibration, or moisture during transportation, storage, installation and operation.
  - Do not lift or move the camera by grasping the camera head. Do not turn the camera head by hand. Doing so may result in mechanical damage.
  - Do not expose camera to any corrosive solid, liquid, or gas to avoid damage to the cover which is made of a plastic material.
  - Ensure that there are no obstacles in the tilt or pan ranges of the camera lens.
  - Never power camera on before installation is complete.
- **Do not dismantle the camera** - The manufacturer is not responsible for any unauthorized modification or dismantling.

## Quick Start

**Step 1.** Please check that all connections are correct before powering on the camera.

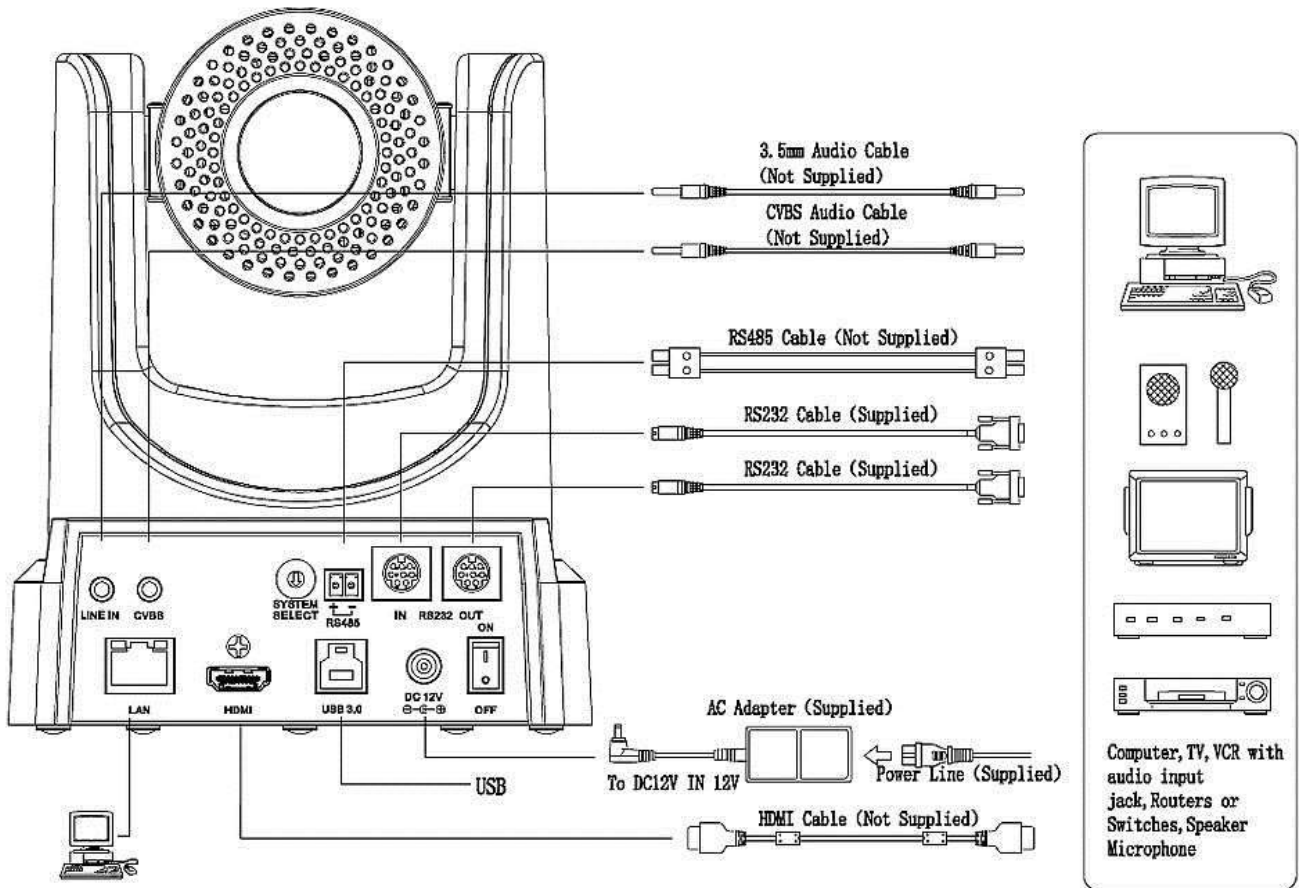



**Step 2.** Set DIP switches

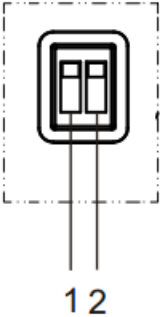

Set both SW-1 and SW-2 to "OFF". This is the "Normal Working Mode".

Mode	SW-1	SW-2	Modes	Default Setting
1	OFF	OFF	Normal Working Mode	Yes
2	ON	OFF	-	-
3	OFF	ON	-	-
4	ON	ON	-	-

**Step 3.** Set the system select switch for your desired video output resolution and frame rate.

For many applications, setting 4 (720p-60) will provide the best overall performance.

For highest possible resolution, use setting 6 (1080p-30), however your actual realized frame rate may be limited to a lower value than 30 fps by your software and/or network connection.

**NOTE:** After changing this dial, you need to restart the camera to see the effect. Turn the camera off.

VIDEO SYSTEM			
0	-	8	-
1	-	9	-
2	1080i60	A	-
3	1080i50	B	-
4	720p60	C	-
5	720p50	D	576i
6	1080p30	E	480i
7	1080p25	F	-

**Step 4.** Press the Switch ON button on the rear of the camera, the power lamp will illuminate.

**Step 5.** The Pan-Tilt mechanism will rotate the lens to the maximum position of top right after the camera starts, then it will return to the "center". The process of initialization is now complete. (Note: If the position preset 0 has been stored, the position preset 0 will be called up after initialization in lieu of "center")

**Step 6. (Optional)** If you want to restore the factory default settings, press [MENU] button to display the OSD menu. Select

the item [MENU] -> [RESTORE DEFAULT] -> [Restore]. Set the value [Yes], press [HOME] button to restore the factory default settings.

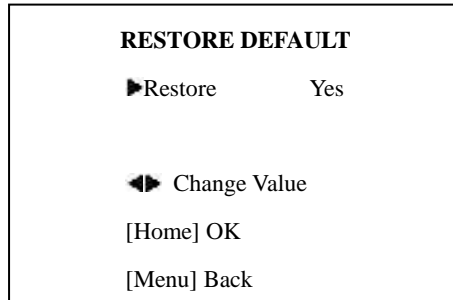

## Features

1. Supports UVC compatible USB 3.0 transmission, the highest rate up to 5Gbps, ensuring real-time lossless HD data transmission.
2. Supports simultaneous USB 3.0, HDMI and IP network streaming up to 1080p-30.
3. Supports non-simultaneous CVBS (composite video) output via RCA connector (480i or 576i).
4. Includes Panasonic's high quality, 1/3 inch, 2.12 million effective pixels, HD CMOS sensor, which can produce a maximum 1920 x 1080 image with a high quality, maximum output frame rate of 60 fps (frames per second).
5. Includes a Olympus, high-quality, telephoto lens, supporting 12x optical zoom and 16x digital zoom.
6. The high SNR (signal to noise ratio) of the CMOS sensor ( $\geq 55\text{dB}$ ), combined with 2D and 3D noise reduction algorithms, effectively reduces noise, even under low illumination conditions.
7. Includes DRC (dynamic range control), allowing for greater image quality and detail across images that are both well-lit and shadowed in the same frame.
8. Includes RS232 and RS485 interfaces for wired remote control. All of the parameters of the camera can be remotely controlled by high-speed communications for joystick and central control system applications.
9. Includes web-based IP remote control interface.

## Product Specifications

<b>Model</b>	PTZ Optics 12X-USB
<b>Type</b>	PTZ Optics USB 3.0 HD 1080p Color Video Camera
Video System	1080i/60,1080i/50, 1080p/30, 1080p/25, 720p/60, 720p/50, 480i, 576i; NTSC, PAL
Sensor	Panasonic 1/3", CMOS, Total Pixels: 2.2M, Effective Pixels: 2.12M
Scanning Mode	Progressive
Lens	12x; f3.5mm – 42.3mm; F1.8 - F2.8
Digital Zoom	16x
Minimal Illumination	0.5 Lux (@F1.8, AGC ON)
Shutter	1/30s - 1/10000s
White Balance	Auto, Indoor, Outdoor, One-Push, Manual
Backlight Compensation	Yes
Digital Noise Reduction	2D & 3D Digital Noise Reduction
Video S/N	≥55dB
Horizontal Angle of View	6.9° - 72.5°
Vertical Angle of View	3.9° - 44.8°
Horizontal Pan Range	±170°
Vertical Tilt Range	-30° to +90°
Pan Speed Range	1.7° - 100°/s
Tilt Speed Range	1.7° - 69.9°/s
Ceiling Installation	Yes
Image Mirroring	Yes
Number of Presets	245
Preset Accuracy	0.1°
Video coding standards	H264, JPEG
HD Output	1x USB 3.0, B-type female
	1x HDMI Ver. 1.3
SD Output	1x CVBS: 3.5mm jack, 1Vp-p, 75Ω (requires adapter cable to connect to standard RCA input)
Network Interface and Output	1x RJ45: 10M/100M Adaptive Ethernet port
Audio Input	1-ch 3.5mm audio interface, LINE IN (embedded on IP Stream only)
Control Input / Output	1x RS-232 In: 8pin Mini-DIN, Max Distance: 30m



	Protocols: VISCA/Pelco-D/Pelco-P
	1x RS-232 Out (pass-through): 8pin Mini-DIN, Max Distance: 30m
	Protocols: VISCA/Pelco-D/Pelco-P
	1x RS-485: 2pin phoenix port, Max Distance: 1500m
	Protocols: VISCA/Pelco-D/Pelco-P
Power Connector	JEITA type (DC IN 12V)
Input Voltage	12VDC (10.8 - 13.0V DC)
Current Consumption	2.0A (Max)
Operating Temperature	23°F - 104°F [-5°C - 40°C]
Storage Temperature	-4°F - 140°F [-20°C - 60°C]
Power Consumption	24W (Max)
Dimensions (w x h x d)	5.56" x 6.5" (7.5" full vertical tilt) x 6.38" [141.2mm x 165.1mm (190.5mm full vertical tilt) x 162mm]
Weight	2.9 lbs. [1.31kg]

## Main Unit

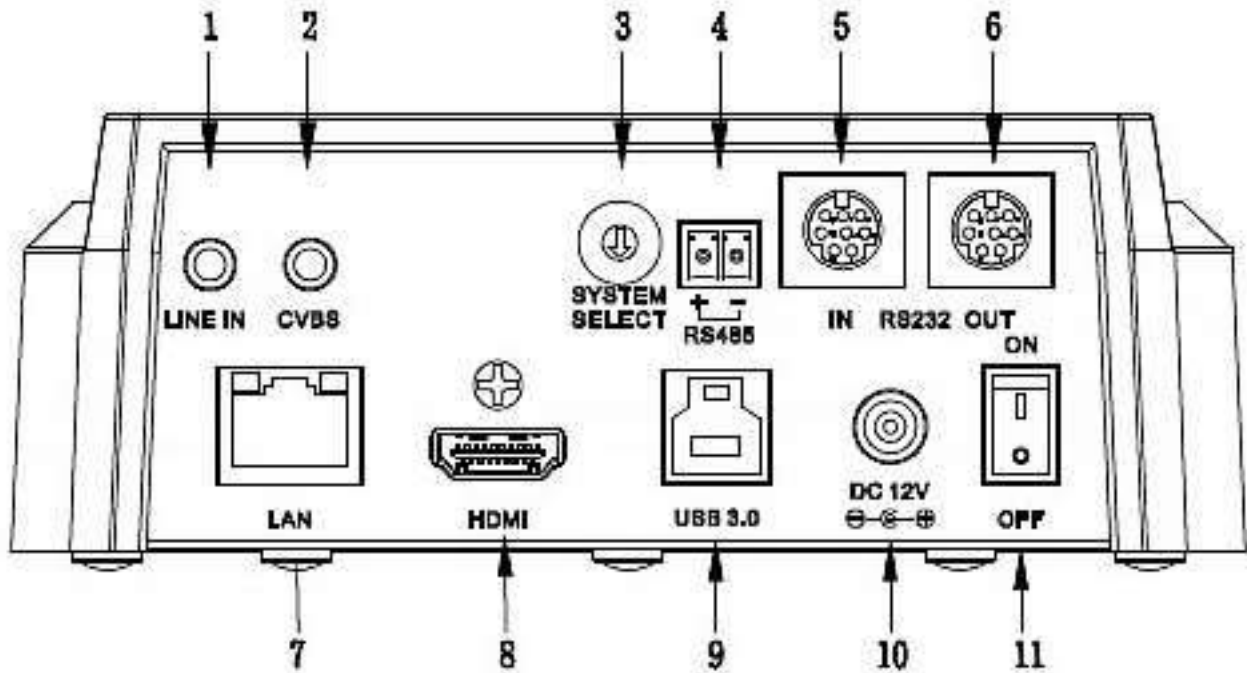

- |  |                                       |
|--|---------------------------------------|
| 1. Audio LINE IN Interface (embeds in IP Stream) | 7. Network (IP streaming and control) |
| 2. CVBS (composite video SD) Interface           | 8. HDMI 1.3 (Digital Video Output)    |
| 3. System select dial (resolution)               | 9. USB 3.0 (USB Video Output)         |
| 4. RS485 jack                                    | 10. DC 12V power jack                 |
| 5. RS232 IN jack                                 | 11. Power switch                      |
| 6. RS232 OUT jack (pass through for daisy chain) |                                       |

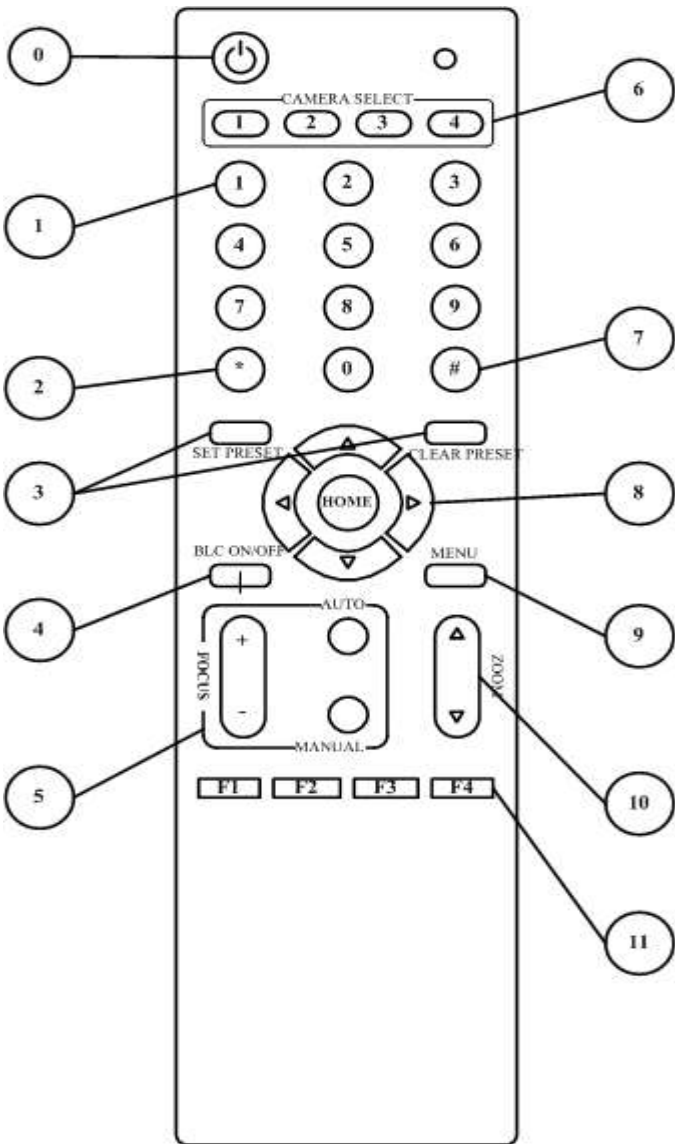

## IR Remote Controller Explanation

### 0. Standby Button

Press this button to enter standby mode. Press it again to enter normal mode.

*(Note: Power consumption in standby mode is approximately half of the normal mode)*

### 1. Position Buttons

To set or call presets

### 2. \* Button

### 3. Set/Clear Preset Buttons

**Set preset:** Stores a preset position

[SET PRESET] + Numeric button (0-9): Sets a corresponding numeric key preset position

**Clear preset:** Erase a preset position

[CLEAR PRESET] + Numeric button (0-9): Erases a corresponding numeric key preset

Or: [\*]+[#]+[CLEAR PRESET]: Erases all of the presets simultaneously

### 4. BLC (Backlight Compensation) Button

**BLC ON/OFF:** Press this button to enable the backlight compensation feature. Press it again to disable backlight compensation. (NOTE: Effective only in auto exposure mode)

Note: If there is bright light behind the subject, the subject will appear dark. In this case, press the backlight ON/OFF button.

To cancel this function, press the backlight ON/OFF button.

## 5. Focus Buttons

Used for focus adjustment.

Press [AUTO] to adjust the focus on the center of the object automatically. To adjust the focus manually, press the [MANUAL] button, and adjust it with [Focus+] (Focus on far object) and [Focus-] (Focus on near object)

## 6. Camera Select Buttons *[Multiple Camera Operation]*

Press the button corresponding to the camera you want to operate with the IR remote controller. (Also, see 11, below)

## 7. # Button

## 8. Pan/Tilt Control Buttons

Press arrow buttons to perform panning and tilting of the lens. Press [HOME] button to face the camera back to front

## 9. Menu Setting

Menu button: Press this button to enter or exit the OSD menu

## 10. Zoom Buttons

Zoom▲: Zoom In on subject for narrower view

Zoom▼: Zoom Out from subject for wider view

## 11. Set Camera IR Address Buttons *[Multiple Camera Operation]*

Press 3 buttons in the sequence shown to set/change the camera's IR address. This allows up to 4 cameras to be controlled from the same IR remote control. Be sure that only one camera is picking up the IR signal when you perform this function. If multiple cameras receive the command, they will all change to the new address. (Also, see 6, above)

Address 1: [\*]+[#]+[F1]

Address 2: [\*]+[#]+[F2]

Address 3: [\*]+[#]+[F3]

Address 4: [\*]+[#]+[F4]

## Using the IR Remote Controller

When the camera is operational, you can use the remote controller to perform panning, tilting, zooming and focusing, as well as store and call back preset positions.

### Button Instructions:

1. In these instructions, ‘press the button’ means to press and release. A special note will be given if holding a button down for more than one second is required.

2. When a button-combination is required, do it in sequence (not simultaneously). For example, ‘[\*] + [#] + [F1]’ means press [\*] first and then press [#] and then press [F1].

### 1. Pan/Tilt Control

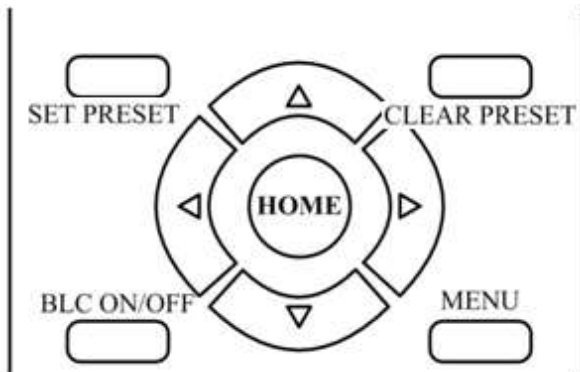

- |                                |              |
|--------------------------------|--------------|
| Tilt up:                       | Press [▲]    |
| Tilt down:                     | Press [▼]    |
| Pan left:                      | Press [◀]    |
| Pan right:                     | Press [▶]    |
| Face the camera back to front: | Press [HOME] |

**Press and hold** the up/down/left/right buttons, to keep panning or tilting from slow to fast, (until the camera

reaches the mechanical limit). The camera stops as soon as the button is released.

### 2. Zoom

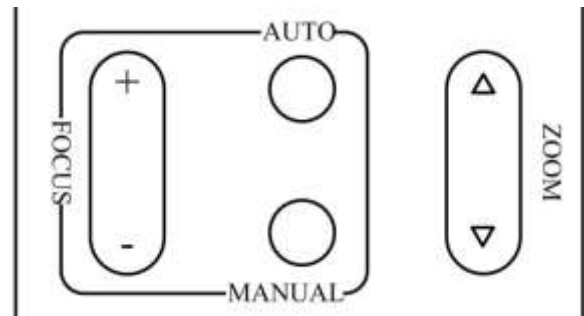

Zoom Out: press [ZOOM▼] button

Zoom In: press [ZOOM▲] button

**Press and hold** the button, to keep zooming in or out (until the lens reaches the mechanical limit). The lens stops as soon as the button is released.



### 3. Focus Control

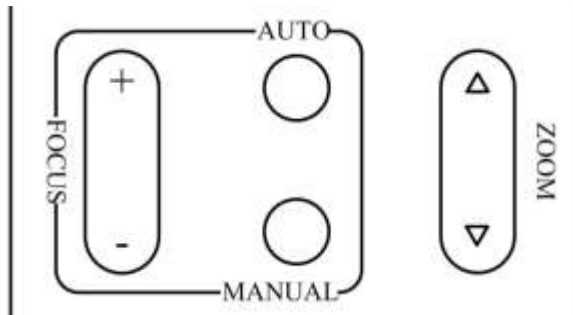

**AUTO:** Change focus mode to AF, which allows the camera to adjust the focus automatically on the center of the image.

**MANUAL:** Change focus mode to MF, which allows the user to adjust the focus manually (see FOCUS FAR & FOCUS NEAR).

**FOCUS FAR:** Press [FOCUS+] button (NOTE: Effective only in MANUAL focus mode)

**FOCUS NEAR:** Press [FOCUS-] button (NOTE: Effective only in MANUAL focus mode)

**Press and hold** the FOCUS FAR or FOCUS NEAR button, allows for continuous adjustment, stopping as soon as the button is released.

### 4. Backlight Switch

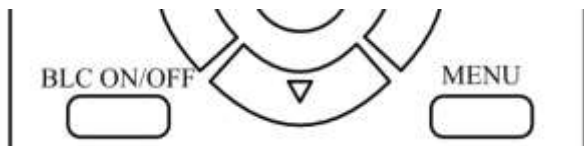

**BLC ON/OFF:** Press this button to enable the backlight compensation. Press it again to disable the backlight compensation. (Note: Backlight is only effective in full auto exposure mode)

### 5. Presets - Setting and Clearing

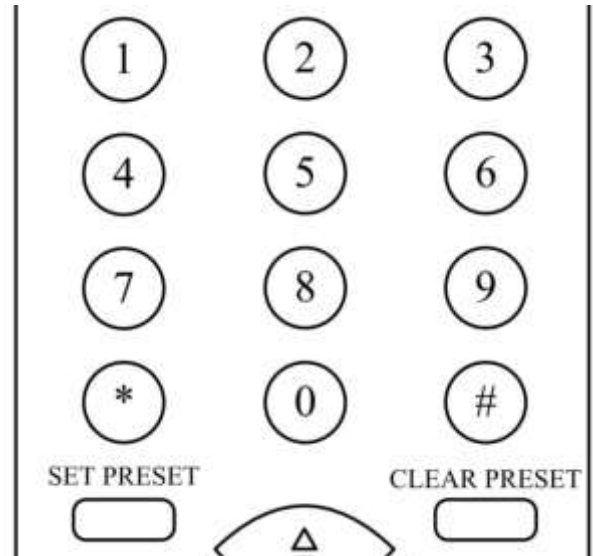

1. To store a preset position: The user should manually setup the shot and then press the [SET PRESET] button first and then press the numeric button 0-9. Ten total preset positions (0-9) are available from the IR remote control (245 available via RS232/RS485/IP Interface).

2. To erase the memory content of a preset position: The user should press the [CLEAR PRESET] button first and then press the numeric button 0-9 associated with that preset.

**Note:**

Pressing [\*]+[#]+[CLEAR PRESET] in sequence will erase all presets in the memory.

### 6. Recalling Presets

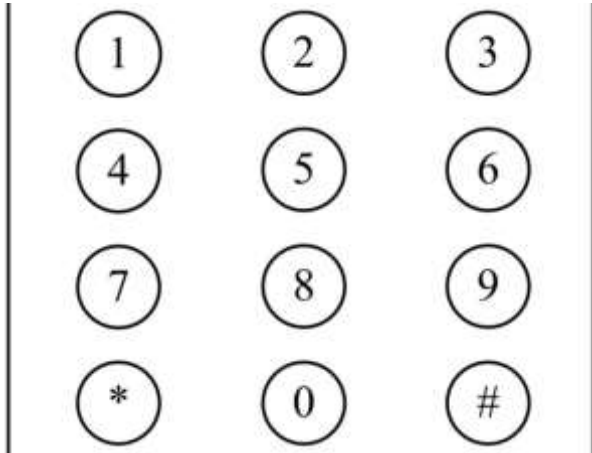

Pressing any of the numeric buttons 0-9 directly will recall a stored preset position and settings.

**Note:**

No action will be executed if a specific numeric preset position has not yet been saved.

**Note:**

Presets assigned via the IP interface do not correlate to presets set via the IR remote control.

### 7. Camera Selection

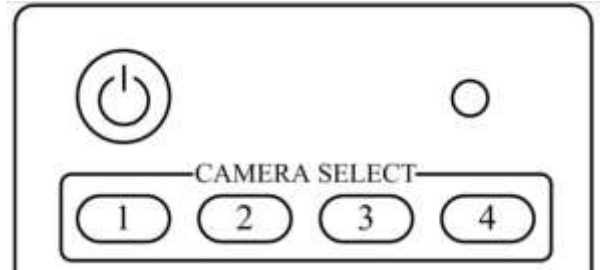

Press the button corresponding to the camera with the IR address that you want to operate. This allows for up to 4 cameras to be operated via the same IR remote in the same room.

### 8. Camera IR Address Set



Press 3 buttons in the sequence shown to set/change the camera's IR address. This allows up to 4 cameras to be controlled from the same IR remote control. Be sure that only one camera is picking up the IR signal when you perform this function. If multiple cameras receive the command, they will all change to the new address.

Address 1: [\*]+[#]+[F1]

Address 2: [\*]+[#]+[F2]

Address 3: [\*]+[#]+[F3]

Address 4: [\*]+[#]+[F4]

## RS-232 Interface

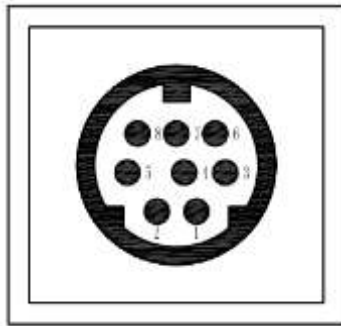

### Camera                      PC/Controller DB-9

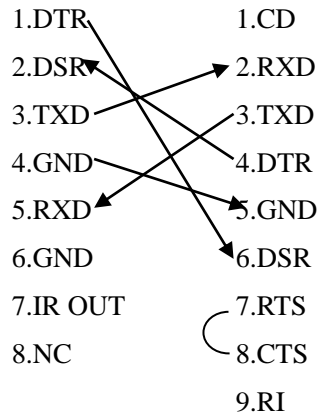

No.	Function
1	DTR
2	DSR
3	TXD
4	GND
5	RXD
6	GND
7	IR OUT
8	NC

### For Control Daisy Chain

#### 1<sup>st</sup> Camera                      2<sup>nd</sup> Camera Mini DIN

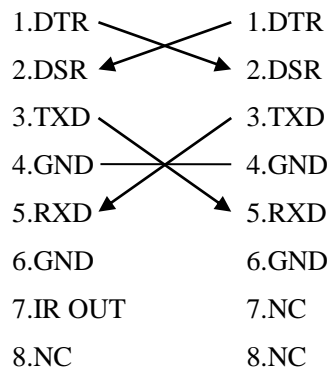

## Serial Communication Control

In default working mode, the camera is able to connect to a VISCA controller with an RS232C serial interface.

➤ **RS232 Communication Control**

The camera can be controlled via RS232. The parameters of RS232C are as follows:

Baud rate: 2400, 4800 or 9600 bps.

Start bit: 1 bit.

Data bit: 8 bits.

Stop bit: 1 bit.

Parity bit: none.

➤ **RS485 Communication Control**

The camera can be controlled via RS485, Half-duplex mode, with support for VISCA, Pelco-D or Pelco-P protocol.

The parameters of RS485 are as follows:

Baud rate: 2400, 4800 or 9600 bps.

Start bit: 1 bit.

Data bit: 8 bits.

Stop bit: 1 bit.

Parity bit: none.

When powered on, Pan and Tilt will rotate to the maximum position of top right after the camera powered up. Then it will return to the “center”. The process of initialization is now complete. (Note: If the position preset 0 has been stored, the position preset 0 will be called up after initialization, in lieu of “center”). After initialization is complete, then the user can control the camera with commands in the command list.

## VISCA Command List

### Part 1: Camera-Issued Messages

ACK/Completion Message			
Command	Function	Command Packet	Comments
ACK/Completion Messages	ACK	z0 4y FF (y: Socket No.)	Returned when the command is accepted.
	Completion	z0 5y FF (y: Socket No.)	Returned when the command has been executed.

z = Camera Address + 8

Error Messages			
Command	Function	Command Packet	Comments
Error Messages	Syntax Error	z0 60 02 FF	Returned when the command format is different or when a command with illegal command parameters is accepted.
	Command Buffer Full	z0 60 03 FF	Indicates that two sockets are already being used (executing two commands) and the command could not be accepted when received.
	Command Canceled	z0 6y 04 FF (y: Socket No.)	Returned when a command which is being executed in a socket specified by the cancel command is canceled. The completion message for the command is not returned.
	No Socket	z0 6y 05 FF (y: Socket No.)	Returned when no command is executed in a socket specified by the cancel command, or when an invalid socket number is specified.
	Command Not Executable	z0 6y 41 FF (y: Execution command Socket No. Inquiry command: 0)	Returned when a command cannot be executed due to current conditions. For example, when commands controlling the focus manually are received during auto focus.



## Part 2: Camera Control Commands

Command	Function	Command Packet	Comments
AddressSet	Broadcast	88 30 01 FF	Address setting
IF_Clear	Broadcast	88 01 00 01 FF	I/F Clear
CAM_Power	On	8x 01 04 00 02 FF	Power ON/OFF
	Off	8x 01 04 00 03 FF	
CAM_Zoom	Stop	8x 01 04 07 00 FF	
	Tele(Standard)	8x 01 04 07 02 FF	
	Wide(Standard)	8x 01 04 07 03 FF	
	Tele(Variable)	8x 01 04 07 2p FF	p = 0(low) - 7(high)
	Wide(Variable)	8x 01 04 07 3p FF	
	Direct	8x 01 04 47 0p 0q 0r 0s FF	pqrs: Zoom Position
CAM_Focus	Stop	8x 01 04 08 00 FF	
	Far(Standard)	8x 01 04 08 02 FF	
	Near(Standard)	8x 01 04 08 03 FF	
	Far(Variable)	8x 01 04 08 2p FF	p = 0(low) - 7(high)
	Near(Variable)	8x 01 04 08 3p FF	
	Direct	8x 01 04 48 0p 0q 0r 0s FF	pqrs: Focus Position
	Auto Focus	8x 01 04 38 02 FF	AF On/Off
	Manual Focus	8x 01 04 38 03 FF	
Auto/Manual	8x 01 04 38 10 FF		
CAM_ZoomFocus	Direct	8x 01 04 47 0p 0q 0r 0s 0t 0u 0v 0w FF	pqrs: Zoom Position tuvw: Focus Position
CAM_WB	Auto	8x 01 04 35 00 FF	Normal Auto
	Indoor mode	8x 01 04 35 01 FF	Indoor mode
	Outdoor mode	8x 01 04 35 02 FF	Outdoor mode
	OnePush mode	8x 01 04 35 03 FF	One Push WB mode
	Manual	8x 01 04 35 05 FF	Manual Control mode
	OnePush trigger	8x 01 04 10 05 FF	One Push WB Trigger
CAM_RGain	Reset	8x 01 04 03 00 FF	Manual Control of R Gain
	Up	8x 01 04 03 02 FF	
	Down	8x 01 04 03 03 FF	
	Direct	8x 01 04 43 00 00 0p 0q FF	pq: R Gain

CAM_Bgain	Reset	8x 01 04 04 00 FF	Manual Control of B Gain
	Up	8x 01 04 04 02 FF	
	Down	8x 01 04 04 03 FF	
	Direct	8x 01 04 44 00 00 0p 0q FF	pq: B Gain
CAM_AE	Full Auto	8x 01 04 39 00 FF	Automatic Exposure mode
	Manual	8x 01 04 39 03 FF	Manual Control mode
	Shutter priority	8x 01 04 39 0A FF	Shutter Priority Automatic Exposure mode
	Iris priority	8x 01 04 39 0B FF	Iris Priority Automatic Exposure mode
	Bright	8x 01 04 39 0D FF	Bright Mode(Manual control)
CAM_SlowShutter	AutoSlowShutterLimit	8x 01 04 2A 0p 00 FF	
CAM_Iris	Reset	8x 01 04 0B 00 FF	Iris Setting
	Up	8x 01 04 0B 02 FF	
	Down	8x 01 04 0B 03 FF	
	Direct	8x 01 04 4B 00 00 0p 0q FF	pq: Iris Position
CAM_Gain	Reset	8x 01 04 0C 00 FF	Gain Setting
	Up	8x 01 04 0C 02 FF	
	Down	8x 01 04 0C 03 FF	
	Direct	8x 01 04 0C 00 00 0p 0q FF	pq: Gain Position
	Gain Limit	8x 01 04 2C 0p FF	p: Gain Position
CAM_Bright	Reset	8x 01 04 0D 00 FF	Bright Setting
	Up	8x 01 04 0D 02 FF	
	Down	8x 01 04 0D 03 FF	
	Direct	8x 01 04 0D 00 00 0p 0q FF	pq: Bright Position
CAM_ExpComp	On	8x 01 04 3E 02 FF	Exposure Compensation On/Off
	Off	8x 01 04 3E 03 FF	
	Reset	8x 01 04 0E 00 FF	Exposure Compensation Amount Setting
	Up	8x 01 04 0E 02 FF	
	Down	8x 01 04 0E 03 FF	
	Direct	8x 01 04 4E 00 00 0p 0q FF	pq: ExpComp Position
CAM_BackLight	On	8x 01 04 33 02 FF	Back Light Compensation On/Off
	Off	8x 01 04 33 03 FF	
CAM_NR(2D)Mode	Auto	8x 01 04 50 02 FF	ND2D Auto/Manual
	Manual	8x 01 04 50 03 FF	

CAM_NR(2D)Level	-	8x 01 04 53 0p FF	p: NR Setting (0: Off, level 1 to 5)
CAM_NR(3D)Level	-	8x 01 04 54 0p FF	p: NR Setting (0: Off, level 1 to 8)
CAM_Flicker	-	8x 01 04 23 0p FF	p: Flicker Settings (0: Off, 1: 50Hz, 2: 60Hz)
CAM_DHotPixel	-	8x 01 04 56 0p FF	p: Dynamic Hot Pixel Setting (0: Off, level 1 to 6)
CAM_ApertureMode( sharpness)	Auto	8x 01 04 05 02 FF	Sharpness Auto
	Manual	8x 01 04 05 02 FF	Sharpness Manual
CAM_Aperture(sharpness)	Reset	8x 01 04 02 00 FF	Aperture Control
	Up	8x 01 04 02 02 FF	
	Down	8x 01 04 02 03 FF	
	Direct	8x 01 04 42 00 00 0p 0q FF	pq: Aperture Gain
CAM_PictureEffect	Off	8x 01 04 63 00 FF	Picture Effect Setting
	B&W	8x 01 04 63 04 FF	
CAM_Memory	Reset	8x 01 04 3F 00 pp FF	pp: Memory Number(=0 to 127)
	Set	8x 01 04 3F 01 pp FF	
	Recall	8x 01 04 3F 02 pp FF	
CAM_LR_Reverse	On	8x 01 04 61 02 FF	Image Flip Horizontal On/Off
	Off	8x 01 04 61 03 FF	
CAM_PictureFlip	On	8x 01 04 66 02 FF	Image Flip Vertical On/Off
	Off	8x 01 04 66 03 FF	
CAM_RegisterValue	-	8x 01 04 24 mn 0p 0q FF	mm: Register No. (=00-7F) pp: Register Value (=00-7F)
CAM_ColorGain	Diret	8x 01 04 49 00 00 00 0p FF	p: Color Gain setting 0h (60%) to Eh (200%)
SYS_Menu	Off	8x 01 06 06 03 FF	Turns off the menu screen
Pan_tiltDrive	Up	8x 01 06 01 VV WW 03 01 FF	VV: Pan speed 0x01 (low speed) to 0x18 (high speed)
	Down	8x 01 06 01 VV WW 03 02 FF	
	Left	8x 01 06 01 VV WW 01 03 FF	WW: Tilt speed 0x01 (low speed) to 0x14 (high speed)
	Right	8x 01 06 01 VV WW 02 03 FF	
	Upleft	8x 01 06 01 VV WW 01 01 FF	YYYY: Pan Position
	Upright	8x 01 06 01 VV WW 02 01 FF	ZZZZ: Tilt Position
	DownLeft	8x 01 06 01 VV WW 01 02 FF	

	DownRight	8x 01 06 01 VV WW 02 02 FF	
	Stop	8x 01 06 01 VV WW 03 03 FF	
	AbsolutePosition	8x 01 06 02 VV WW 0Y 0Y 0Y 0Y 0Z 0Z 0Z 0Z FF	
	RelativePosition	8x 01 06 03 VV WW 0Y 0Y 0Y 0Y 0Z 0Z 0Z 0Z FF	
	Home	8x 01 06 04 FF	
	Reset	8x 01 06 05 FF	
Pan_tiltLimitSet	LimitSet	8x 01 06 07 00 0W 0Y 0Y 0Y 0Y 0Z 0Z 0Z 0Z FF	W: 1 UpRight 0: DownLeft YYYY: Pan Limit Position ZZZZ: Tilt Position
	LimitClear	8x 01 06 07 01 0W 07 0F 0F 0F 07 0F 0F 0F FF	
CAM_AFSensitivity	High	8x 01 04 58 01 FF	AF Sensitivity High/Normal/Low
	Normal	8x 01 04 58 02 FF	
	Low	8x 01 04 58 03 FF	
CAM_SettingReset	Reset	8x 01 04 A0 10 FF	Reset Factory Setting
CAM_Brightness	Direct	8x 01 04 A1 00 00 0p 0q FF	pq: Brightness Position
CAM_Contrast	Direct	8x 01 04 A2 00 00 0p 0q FF	pq: Contrast Position
CAM_Flip	Off	8x 01 04 A4 00 FF	Single Command For Video Flip
	Flip-H	8x 01 04 A4 01 FF	
	Flip-V	8x 01 04 A4 02 FF	
	Flip-HV	8x 01 04 A4 03 FF	
CAM_SettingSave	Save	8x 01 04 A5 10 FF	Save Current Setting
CAM_Iridix	Direct	8x 01 04 A7 00 00 0p 0q FF	pq: Iridix Position
CAM_AWBSensitivity	High	8x 01 04 A9 00 FF	High
	Normal	8x 01 04 A9 01 FF	Normal
	Low	8x 01 04 A9 02 FF	Low
CAM_AFZone	Top	8x 01 04 AA 00 FF	AF Zone weight select
	Center	8x 01 04 AA 01 FF	
	Bottom	8x 01 04 AA 02 FF	
CAM_ColorHue	Direct	8x 01 04 4F 00 00 00 0p FF	p: Color Hue setting 0h (- 14 degrees) to Eh (+14 degrees)

### Part 3: Query Commands

Inquiry Command List			
Command	Command packed	Inquiry Packet	Comments
CAM_PowerInq	8x 09 04 00 FF	y0 50 02 FF	On
		y0 50 03 FF	Off(Standby)
		y0 50 04 FF	Internal power circuit error
CAM_ZoomPosInq	8x 09 04 47 FF	y0 50 0p 0q 0r 0s FF	pqrs: Zoom Position
CAM_FocusAFMode Inq	8x 09 04 38 FF	y0 50 02 FF	Auto Focus
		y0 50 03 FF	Manual Focus
CAM_FocusPosInq	8x 09 04 48 FF	y0 50 0p 0q 0r 0s FF	pqrs: Focus Position
CAM_WBModeInq	8x 09 04 35 FF	y0 50 00 FF	Auto
		y0 50 01 FF	Indoor mode
		y0 50 02 FF	Outdoor mode
		y0 50 03 FF	OnePush mode
		y0 50 05 FF	Manual
CAM_RGainInq	8x 09 04 43 FF	y0 50 00 00 0p 0q FF	pq: R Gain
CAM_BGainInq	8x 09 04 44 FF	y0 50 00 00 0p 0q FF	pq: B Gain
CAM_AEModeInq	8x 09 04 39 FF	y0 50 00 FF	Full Auto
		y0 50 03 FF	Manual
		y0 50 0A FF	Shutter priority
		y0 50 0B FF	Iris priority
		y0 50 0D FF	Bright
CAM_ShutterPosInq	8x 09 04 4A FF	y0 50 00 00 0p 0q FF	pq: Shutter Position
CAM_IrisPosInq	8x 09 04 4B FF	y0 50 00 00 0p 0q FF	pq: Iris Position
CAM_BrightPosInq	8x 09 04 4D FF	y0 50 00 00 0p 0q FF	pq: Bright Position
CAM_ExpCompModeInq	8x 09 04 3E FF	y0 50 02 FF	On
		y0 50 03 FF	Off
CAM_ExpCompPosInq	8x 09 04 4E FF	y0 50 00 00 0p 0q FF	pq: ExpComp Position
CAM_BacklightMode Inq	8x 09 04 33 FF	y0 50 02 FF	On
		y0 50 03 FF	Off
CAM_Nosise2DMode Ing	8x 09 04 50 FF	y0 50 02 FF	Auto Noise 2D
		y0 50 03 FF	Manual Noise 3D



CAM_Noise2DLevel	8x 09 04 53 FF	y0 50 0p FF	Noise Reduction (2D) p: 0 to 5
CAM_Noise3DLevel	8x 09 04 54 FF	y0 50 0p FF	Noise Reduction (3D) p: 0 to 8
CAM_FlickerModeInq	8x 09 04 55 FF	y0 50 0p FF	p: Flicker Settings(0: OFF, 1: 50Hz, 2: 60Hz)
CAM_ApertureModelInq(Sharpness)	8x 09 04 05 FF	y0 50 02 FF	Auto Sharpness
		y0 50 03 FF	Manual Sharpness
CAM_ApertureInq(Sharpness)	8x 09 04 42 FF	y0 50 00 00 0p 0q FF	pq: Aperture Gain
CAM_PictureEffectModeInq	8x 09 04 63 FF	y0 50 02 FF	Off
		y0 50 04 FF	B&W
CAM_MemoryInq	8x 09 04 3F FF	y0 50 0p FF	p: Memory number last operated.
SYS_MenuModeInq	8x 09 06 06 FF	y0 50 02 FF	On
		y0 50 03 FF	Off
CAM_LR_ReverseInq	8x 09 04 61 FF	y0 50 02 FF	On
		y0 50 03 FF	Off
CAM_PictureFlipInq	8x 09 04 66 FF	y0 50 02 FF	On
		y0 50 03 FF	Off
CAM_RegisterValueInq	8x 09 04 24 mm FF	y0 50 0p 0p ff	mm: Register No. (00 to FF) pp: Register Value (00 to FF)
CAM_ColorGainInq	8x 09 04 49 FF	y0 50 00 00 00 0p FF	p: Color Gain setting 0h (60%) to Eh (200%)
CAM_IDInq	8x 09 04 22 FF	y0 50 0p 0q 0r 0s FF	pqrs: Camera ID
CAM_VersionInq	8x 09 00 02 FF	y0 50 ab cd mn pq rs tu vw FF	ab: Factory Code(00: VHD, 01:MR, 08:T) cd: Hardware Version mnpq: ARM Version rstu: FPGA Version vw: Camera model 01: C Type 02: M Type 03: S Type
VideoSystemInq	8x 09 06 23 FF	y0 50 00 FF	1920x1080i60
		y0 50 01 FF	1920x1080p30

		y0 50 02 FF	1280x720p60
		y0 50 04 FF	NTSC
		y0 50 05 FF	NTSC
		y0 50 06 FF	NTSC
		y0 50 07 FF	1920x1080p60
		y0 50 08 FF	1920x1080i50
		y0 50 09 FF	1920x1080p25
		y0 50 0A FF	1280x720p50
		y0 50 0C FF	PAL
		y0 50 0D FF	PAL
		y0 50 0E FF	PAL
IR_Receive	8x 09 06 08 FF	y0 50 02 FF	On
		y0 50 03 FF	Off
Pan-tiltMaxSpeedInq	8x 09 06 11 FF	y0 50 ww zz FF	ww: Pan Max Speed zz: Tilt Max Speed
Pan-tiltPosInq	8x 09 06 12 FF	y0 50 0w 0w 0w 0w 0z 0z 0z 0z FF	www: Pan Position zzzz: Tilt Position
CAM_TypeInq	8x 09 00 03 FF	y0 50 01 FF	C Type
		y0 50 02 FF	M Type
		y0 50 03 FF	S Type
CAM_DateInq	8x 09 00 04 FF	y0 50 0r ss uu vv ww 0D FF	Version dater: Big Version Numbers: Little Version Numberuuuu: Yearvv: Monthww: Day
CAM_ModeInq	8x 09 04 A6 FF	y0 50 00 FF	Mode0
		y0 50 02 FF	Mode2
CAM_GainLimitInq	8x 09 04 2C FF	y0 50 0q FF	p: Gain Limit
CAM_DHotPixelInq	8x 09 04 56 FF	y0 50 0q FF	p: Dynamic Hot Pixel Setting (0: Off, level 1 to 6)
CAM_AFSensitivityInq	8x 09 04 58 FF	y0 50 01 FF	High
		y0 50 02 FF	Normal
		y0 50 03 FF	Low
CAM_BrightnessInq	8x 09 04 A1 FF	y0 50 00 00 0p 0q FF	pq: Brightness Position
CAM_ContrastInq	8x 09 04 A2 FF	y0 50 00 00 0p 0q FF	pq: Contrast Position
CAM_FlipInq	8x 09 04 A4 FF	y0 50 00 FF	Off

		y0 50 01 FF	Flip-H
		y0 50 02 FF	Flip-V
		y0 50 03 FF	Flip-HV
CAM_IridixInq	8x 09 04 A7 FF	y0 50 00 00 0p 0q FF	pq: Iridix Position
CAM_AFZone	8x 09 04 AA FF	y0 50 00 FF	Top
		y0 50 01 FF	Center
		y0 50 02 FF	Bottom
CAM_ColorHueInq	8x 09 04 4F FF	y0 50 00 00 00 0p FF	p: Color Hue setting 0h (- 14 degrees) to Eh (+14 degrees)
CAM_AWBSensitivityInq	8x 09 04 A9 FF	y0 50 00 FF	High
		y0 50 01 FF	Normal
		y0 50 02 FF	Low

Block Inquiry Command List			
Command	Command packed	Inquiry Packet	Comments
CAM_LensBlockInq	8x 09 7E 7E 00 FF	y0 50 0u 0u 0u 0u 00 00 0v 0v 0v 0v 00 0w 00 FF	uuuu: Zoom Position vvvv: Focus Position w.bit0: Focus Mode 1: Auto 0: Manual
CAM_CameraBlockInq	8x 09 7E 7E 01 FF	y0 50 0p 0p 0q 0q 0r 0s tt 0u vv ww 00 xx 0z FF	pp: R_Gain qq: B_Gain r: WB Mode s: Aperture tt: AE Mode u.bit2: Back Light u.bit1: Exposure Comp. vv: Shutter Position ww: Iris Position xx: Bright Position z: Exposure Comp. Position
CAM_OtherBlockInq	8x 09 7E 7E 02 FF	y0 50 0p 0q 00 0r 00 00 00 00 00 00 00 00 FF	p.bit0: Power 1:On, 0:Off q.bit2: LR Reverse 1:On, 0:Off r.bit3~0: Picture Effect Mode

CAM_EnlargementBlockInq	8x 09 7E 7E 03 FF	y0 50 00 00 00 00 00 00 00 0p 0q rr 0s 0t 0u FF	<p>p: AF sensitivity          q.bit0: Picture flip(1:On, 0:Off)          rr.bit6~3: Color Gain(0h(60%) to Eh(200%))          s: Flip(0: Off, 1:Flip-H, 2:Flip-V, 3:Flip-HV)          t.bit2~0: NR2D Level          u: Gain Limit</p>
-------------------------	-------------------	--	--

**Note:**

The [x] in the above table is the camera address, [y] = [x + 8].

**Pelco-D Protocol Command List**

Function	Byte1	Byte2	Byte3	Byte4	Byte5	Byte6	Byte7
Up	0xFF	Address	0x00	0x08	Pan Speed	Tilt Speed	SUM
Down	0xFF	Address	0x00	0x10	Pan Speed	Tilt Speed	SUM
Left	0xFF	Address	0x00	0x04	Pan Speed	Tilt Speed	SUM
Right	0xFF	Address	0x00	0x02	Pan Speed	Tilt Speed	SUM
Zoom In	0xFF	Address	0x00	0x20	0x00	0x00	SUM
Zoom Out	0xFF	Address	0x00	0x40	0x00	0x00	SUM
Focus Far	0xFF	Address	0x00	0x80	0x00	0x00	SUM
Focus Near	0xFF	Address	0x01	0x00	0x00	0x00	SUM
Set Preset	0xFF	Address	0x00	0x03	0x00	Preset ID	SUM
Clear Preset	0xFF	Address	0x00	0x05	0x00	Preset ID	SUM
Call Preset	0xFF	Address	0x00	0x07	0x00	Preset ID	SUM
Auto Focus	0xFF	Address	0x00	0x2B	0x00	0x01	SUM
Manual Focus	0xFF	Address	0x00	0x2B	0x00	0x02	SUM
Query Pan Position	0xFF	Address	0x00	0x51	0x00	0x00	SUM
Query Pan Position Response	0xFF	Address	0x00	0x59	Value High Byte	Value Low Byte	SUM
Query Tilt Position	0xFF	Address	0x00	0x53	0x00	0x00	SUM
Query Tilt Position Response	0xFF	Address	0x00	0x5B	Value High Byte	Value Low Byte	SUM
Query Zoom Position	0xFF	Address	0x00	0x55	0x00	0x00	SUM
Query Zoom Position Response	0xFF	Address	0x00	0x5D	Value High Byte	Value Low Byte	SUM



## Pelco-P Protocol Command List

Function	Byte1	Byte2	Byte3	Byte4	Byte5	Byte6	Byte7	Byte8
Up	0xA0	Address	0x00	0x08	Pan Speed	Tilt Speed	0xAF	XOR
Down	0xA0	Address	0x00	0x10	Pan Speed	Tilt Speed	0xAF	XOR
Left	0xA0	Address	0x00	0x04	Pan Speed	Tilt Speed	0xAF	XOR
Right	0xA0	Address	0x00	0x02	Pan Speed	Tilt Speed	0xAF	XOR
Zoom In	0xA0	Address	0x00	0x20	0x00	0x00	0xAF	XOR
Zoom Out	0xA0	Address	0x00	0x40	0x00	0x00	0xAF	XOR
Focus Far	0xA0	Address	0x00	0x80	0x00	0x00	0xAF	XOR
Focus Near	0xA0	Address	0x01	0x00	0x00	0x00	0xAF	XOR
Set Preset	0xA0	Address	0x00	0x03	0x00	Preset ID	0xAF	XOR
Clear Preset	0xA0	Address	0x00	0x05	0x00	Preset ID	0xAF	XOR
Call Preset	0xA0	Address	0x00	0x07	0x00	Preset ID	0xAF	XOR
Auto Focus	0xA0	Address	0x00	0x2B	0x00	0x01	0xAF	XOR
Manual Focus	0xA0	Address	0x00	0x2B	0x00	0x02	0xAF	XOR
Query Pan Position	0xA0	Address	0x00	0x51	0x00	0x00	0xAF	XOR
Query Pan Position Response	0xA0	Address	0x00	0x59	Value High Byte	Value Low Byte	0xAF	XOR
Query Tilt Position	0xA0	Address	0x00	0x53	0x00	0x00	0xAF	XOR
Query Tilt Position Response	0xA0	Address	0x00	0x5B	Value High Byte	Value Low Byte	0xAF	XOR
Query Zoom Position	0xA0	Address	0x00	0x55	0x00	0x00	0xAF	XOR
Query Zoom Position Response	0xA0	Address	0x00	0x5D	Value High Byte	Value Low Byte	0xAF	XOR

## Menu Settings

### 1. MENU

Press the [MENU] button to display the main menu on the screen. Use the arrow button to move the cursor to the item to be set. Press the [HOME] button to enter the corresponding sub-menu.

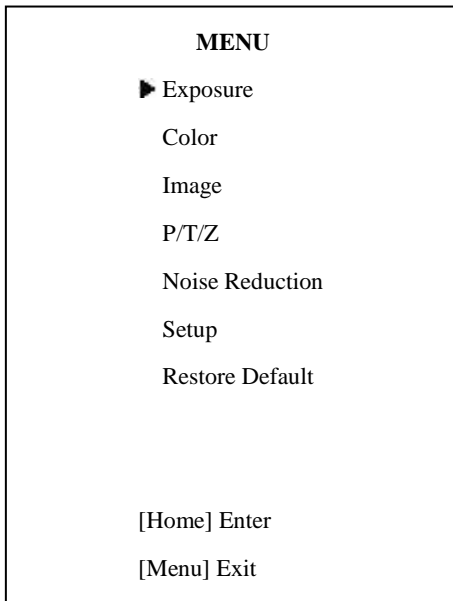

### 2. EXPOSURE

Move the cursor to the Exposure item in the main menu and press [HOME] button. The EXPOSURE menu appears, as shown in the following figure.

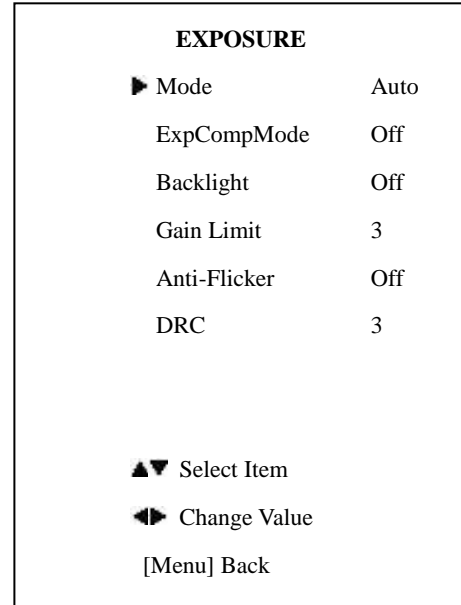

**Mode:** Exposure mode. Optional items: Auto, Manual, SAE, AAE, Bright

**ExpCompMode:** Exposure compensation mode, Optional items: On, Off (Effective only in Auto mode). ExpComp: Exposure compensation value, Optional items: -7 ~ 7 (Effective only when ExpCompMode is On)

**Backlight:** Set the backlight compensation, Optional items: On, Off (Effective only in Auto mode)

**Gain Limit:** Maximum gain limit. Optional items: 0 ~ 15 (Effective only in Auto, AAE, Bright modes)

**Anti-Flicker:** Anti-flicker. Optional items: On, Off, 50Hz, 60Hz (Effective only in Auto, Bright mode)

**DRC:** Dynamic Range Control Strength, Optional items: 0 ~ 8.

**Bright:** Intensity control, Optional items: 00~17.  
(Effective only in Bright mode)

**Iris:** Aperture value. Optional items: F1.8, F2.0, F2.4, F2.8, F3.4, F4.0, F4.8, F5.6, F6.8, F8.0, F9.6, F11.0, Close (Effective only in Manual, AAE mode)

**Shutter:** Shutter value. Optional items: 1/30, 1/60, 1/90, 1/100, 1/125, 1/180, 1/250, 1/350, 1/500, 1/725, 1/1000, 1/1500, 1/2000, 1/3000, 1/4000, 1/6000, 1/10000 (Effective only in Manual, SAE mode)

### 3. COLOR

Move the cursor to the Color item in the main menu and press [HOME] button, COLOR menu appears, as shown in the following figure.

COLOR	
▶ WB Mode	Auto
RG Tuning	0
BG Tuning	0
Saturation	100%
Hue	7
IR Filter	3
AWB sens	Low
Style	Style1
▲▼ Select Item	
◀▶ Change Value	
[Menu] Back	

**WB-Mode:** White balance mode. Optional items: Auto, Indoor, Outdoor, One Push (ok), Manual

**RG:** Red gain. Optional items: 0~255 (Effective only in Manual mode)

**BG:** Blue gain. Optional items: 0~255  
(Effective only in Manual mode)

**RG Tuning:** Red gain fine-tuning, Optional items: -10~10 (Effective only in Auto, Indoor, Outdoor mode)

**BG Tuning:** Blue gain fine-tuning, Optional items: -10~10 (Effective only in Auto, Indoor, Outdoor mode)

**Saturation:** Color Saturation. Optional items: 60% ~ 200%.

**Hue:** Chroma adjustment, Optional items: 0 ~ 14

**IR Filter:** IR Filter, Optional items: 1 ~ 3

**AWB sens:** The white balance sensitivity, Optional items: Normal, High, Low.

**Style:** Optional items: Style1, Style2, Style3.

### 4. IMAGE

Move the cursor to the Image item in the main menu and press [HOME] button, IMAGE menu appears, as shown in the following figure.

IMAGE	
▶ Luminance	6
Contrast	8
Sharpness	1
Flip-H	Off
Flip-V	Off
B&W-Mode	Off
Gamma	Default
▲▼ Select Item	
◀▶ Change Value	
[Menu] Back	

**Luminance:** Brightness adjustment. Optional items: 0 ~ 14  
**Contrast:** Contrast adjustment. Optional items: 0 ~ 14  
**Sharpness:** Sharpness adjustment. Optional items: Auto, 0 ~ 15  
**Flip-H:** Image flipped horizontally. Optional items: On, Off  
**Flip-V:** Image Flip Vertical. Optional items: On, Off  
**B&W-Mode:** Image color. Optional items: On, Off  
**Gamma:** Optional items: Default 0.45, 0.5, 0.56, 0.63

### 5. P/T/Z

P/T/Z	
▶ SpeedByZoom	On
AF-Zone	Center
AF-Sense	Low
▲▼ Select Item	
◀▶ Change Value	
[Menu] Back	

**SpeedByZoom:** The depth of field scale switch, Optional items: On, Off  
**AF-Zone:** Auto focusing area, Optional items: Top, Center, Bottom  
**AF-Sense:** Automatic focusing sensitivity options, Optional items: Low, Normal, High

### 6. NOISE REDUCTION

Move the cursor to the Noise Reduction item in the main menu and press [HOME] button, NOISE REDUCTION menu appears, as shown in the following figure.

**NOISE REDUCTION**

- ▶ NR2D-Level 3
- NR3D-Level 3
- D-HotPixel Off

- ▲▼ Select Item
- ◀▶ Change Value
- [Menu] Back

**SETUP**

- ▶ Language EN
- Protocol VISCA
- V\_Address 1
- V\_AddrFix Off
- Net Mode Serial
- Baudrate 9600

- ▲▼ Select Item
- ◀▶ Change Value
- [Menu] Back

**NR2D-Level:** 2D noise reduction. Optional items: Off, Auto, 1 ~ 5

**NR3D-Level:** 3D noise reduction. Optional items: Off, 1 ~ 8

**D-HotPixel:** Dynamic bad points, Optional items: Off, 1 ~ 5

## 7. SETUP

Move the cursor to the Setup item in the main menu and press [HOME] button, SETUP menu appears, as shown in the following figure.

**Language:** Menu language, Optional items: EN, Chinese

**Protocol:** Control protocol type. Optional items: AUTO, VISCA, PELCO-D, PELCO-P

**V\_Address:** VISCA address, Decided according to the argument: AUTO, VISCA; Optional items: 1 ~ 7

**P\_D\_Address:** PELCO-D address; Optional items: 0 ~ 254

**P\_P\_Address:** PELCO-P address; Optional items: 0 ~ 31

**V\_AddrFix:** Lock IR Address from changing via serial control, Optional items: On, Off (When set to On, 88 30 01 FF Command will not function)

**Net Mode:** Set the serial port control networking, Optional items: Serial, Parallel

**Baudrate:** Serial port baud rate. Optional items: 2400, 4800, 9600



## 8. RESTORE DEFAULT

Move the cursor to the Restore Default item in the main menu and press [HOME] button, RESTORE DEFAULT menu appears, as shown in the following figure.

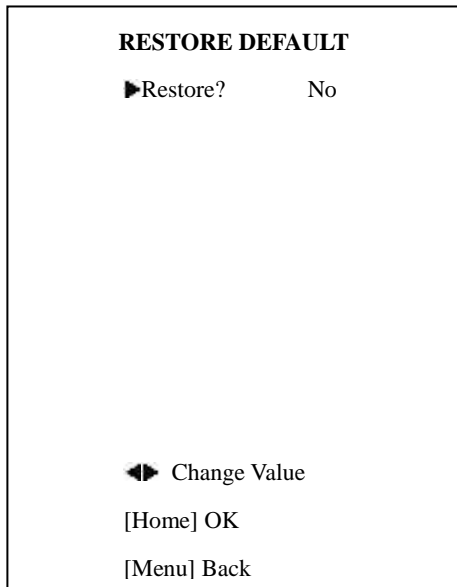

## 9. Saving

**Save:** Save setting changes. Optional items: Yes, No

**Restore:** Reset all settings to factory default settings.

Optional items: Yes, No

Note: Press [HOME] button to confirm, All parameters are then restored to default values, including IR Remote address, VISCA Address and Pelco addresses.

## Network Connection

### 1. Operating Environment

Operating System: Windows 2000/2003/XP/Vista/7/8.1

Network Protocol: TCP/IP

Client PC: P4/128M RAM/40G HD/ support for scaled graphics card, support for DirectX8.0 or more advanced version.

### 2. Equipment Installation

1) Connect camera to your network via a CAT5 or CAT6 patch cable or directly to your PC via a CAT5 or CAT6 crossover cable.

2) Turn on camera power.

3) If successful, the orange network light will illuminate and the green light will start flashing. If unsuccessful, the patch cable is bad, you are using the wrong cable (patch *aka* "straight-thru" cable for connection through a LAN; crossover for a direct PC connection) or you have connected to an inactive network jack.

### 3. Network Connection

Connection method between network camera and computer, as in pictures 1.1 and 1.2, below:

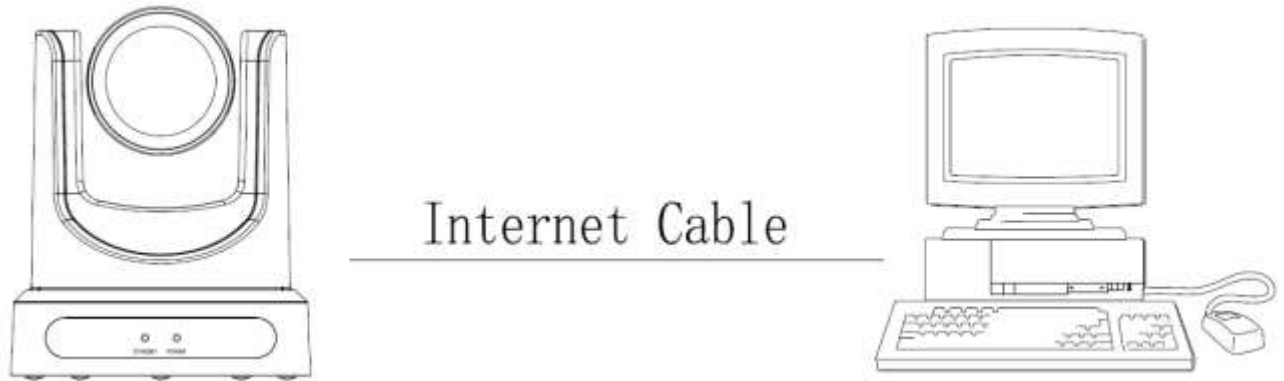

**Picture 1.1 Direct connections via “cross-over” network cable**

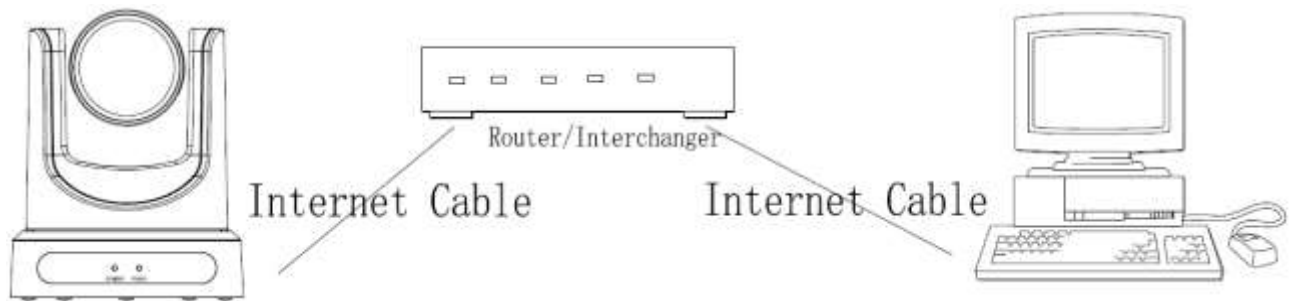

**Picture 1.2 Connections to LAN via patch cable to LAN wall jack or LAN switch**

## IP camera viewing and control via IP

### 1 Setting up the camera's IP address:

1.1 Connect the Camera to the network (or PC). Turn on the camera power. The current IP address can be searched via the "Upgrade" software (software upgrading tool, named "upgrade\_En.exe" or "upgrade.exe" that can easily be downloaded from the <http://www.ptzoptics.com/downloads/> web site). Run "upgrade.exe". Click the [Search] tab. Click the "Search" Button. The software will show the camera's IP address, subnet mask, network gateway and the camera's MAC address, as shown below:

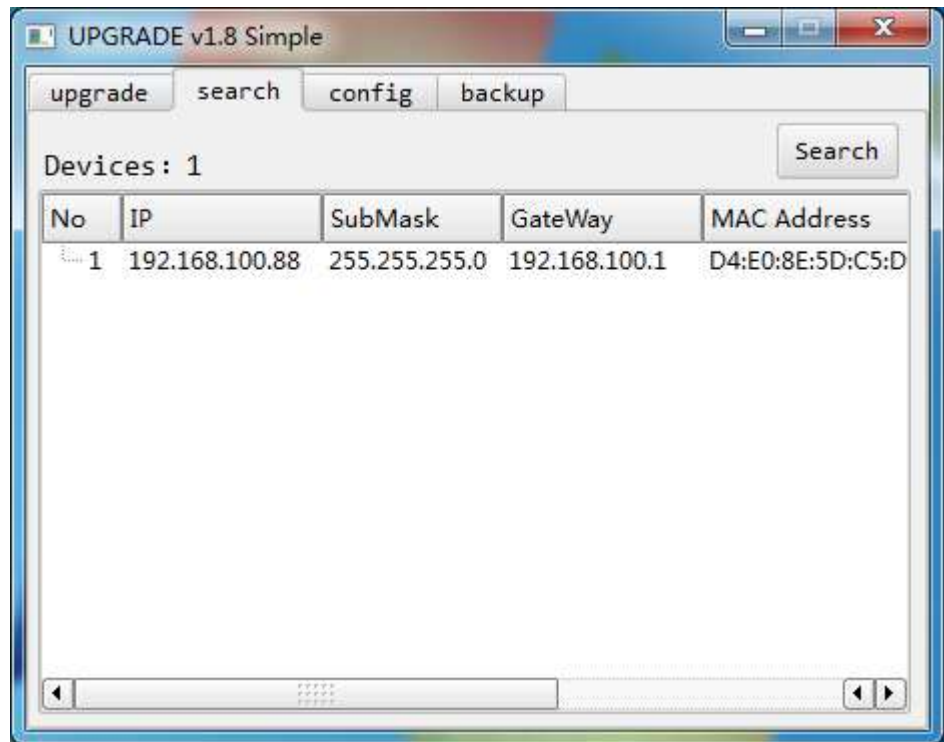

If you have multiple cameras on the network, you can identify the camera you are working with by disconnecting and reconnecting the camera to see which MAC address belongs to that camera.

To set the IP address for the camera to work within your network environment, click the [config] tab or right click the listing in the [search] tab and select "config".

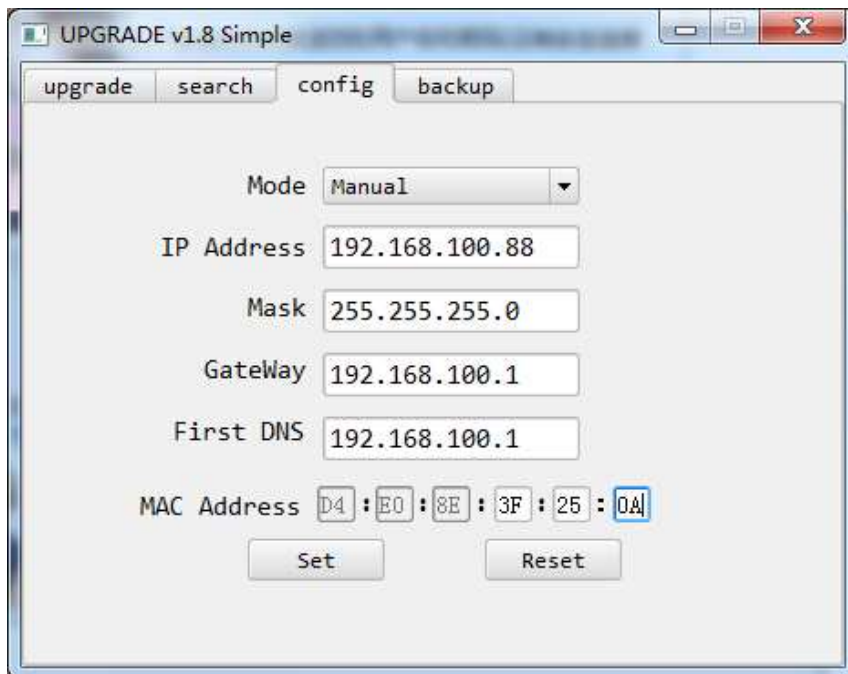
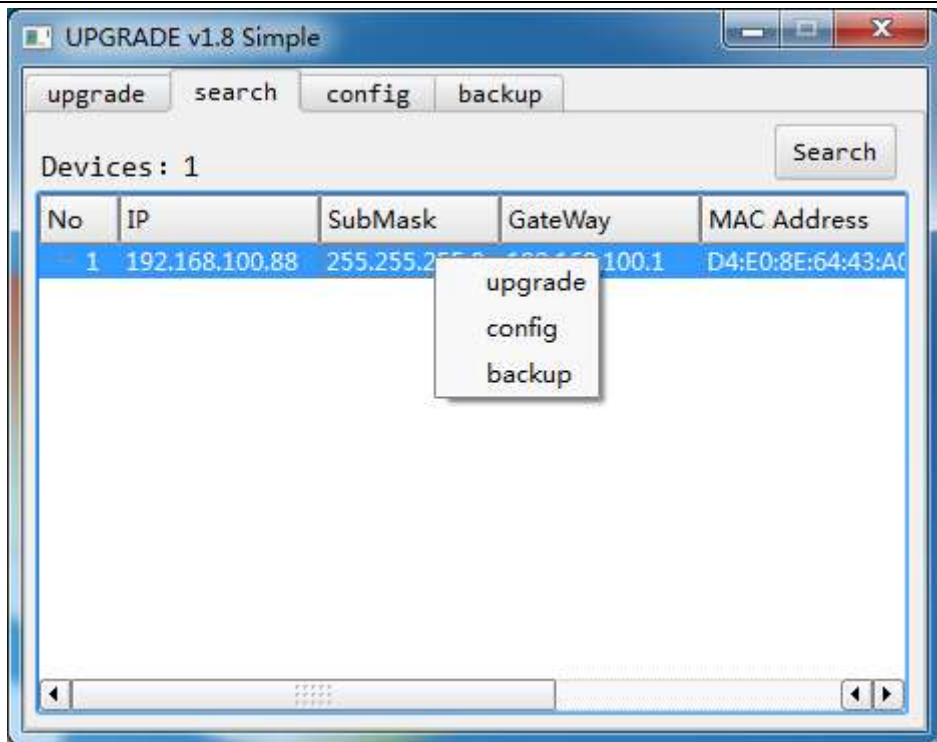



Enter your new IP information as required and click the “Set” button. Note: In order to view or control the camera, the PC must be able to see this IP address, either by virtue of being in the same subnet or by appropriate routing settings in a router or network switch that connects these networks.



**Camera’s Factory Default IP Address and Login:**

**IP: 192.168.100.88**

**User name: admin**

**Password: admin**

**2 Accessing the IP Camera:**

2.1 Input **http://[your IP address]**, (where [your IP address] is the IP address set for the camera) into the URL line of your browser. Results may be better with IE web browser; others may cause latency or fail to show a live image.

A login window will pop up, as shown below:



2.2 Input the User name and the Password and click "OK" to enter the web interface.



 **NOTE !**

If connecting to this type of camera for the first time, you may need to install the free VLC player software. Please go to <http://www.videolan.org/vlc/>. Click the download VLC button. If a download window appears, click “Save”. Then install the VLC player software by executing the file from your Downloads directory.



After installing the VLC player, log back into the camera’s IP interface:

## IP Camera accessed/controlled by WAN (internet)

1. Setup camera for IP (see “setting up the camera’s IP” section above)
2. Setup “Dynamic DNS” for your IP address
  - 2.1. Select a Dynamic DNS provider and setup a host/domain name for your camera.
  - 2.2. Setup your network router for port forwarding, so that incoming requests to the Host/Domain Name are forwarded to your camera.

## VLC stream media player monitoring

### 1. VLC media player procedure

- 1.1 Install the free VLC Media Player software (be sure to get appropriate version for your OS, Windows, MAC).  
<http://www.videolan.org/vlc/index.html>
- 1.2 Open VLC media player, select the "Media" menu and click on “Open Network Stream”, or type "Ctrl+N".

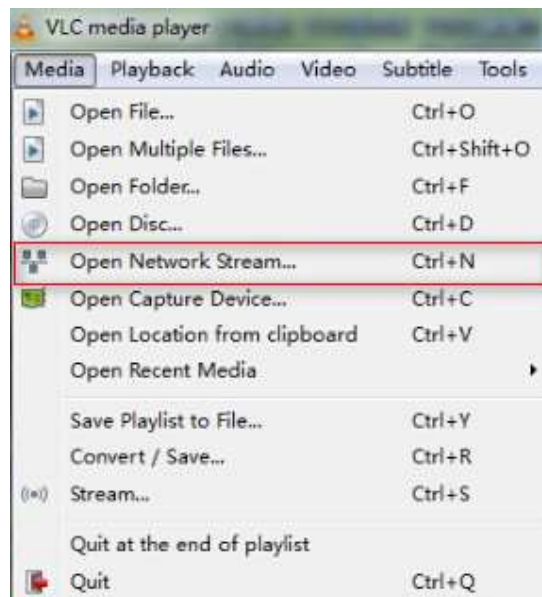

- 1.3 Type in the URL address as follows: `rtsp://<Your Ip Address>:<your port number>/<desired stream number>` (1 for Main stream or 2 for sub stream). For example, you would type: `rtsp://192.168.100.88:554/1` Note: When the RTSP port number is the default value of 554 it may be omitted from the address as shown below.

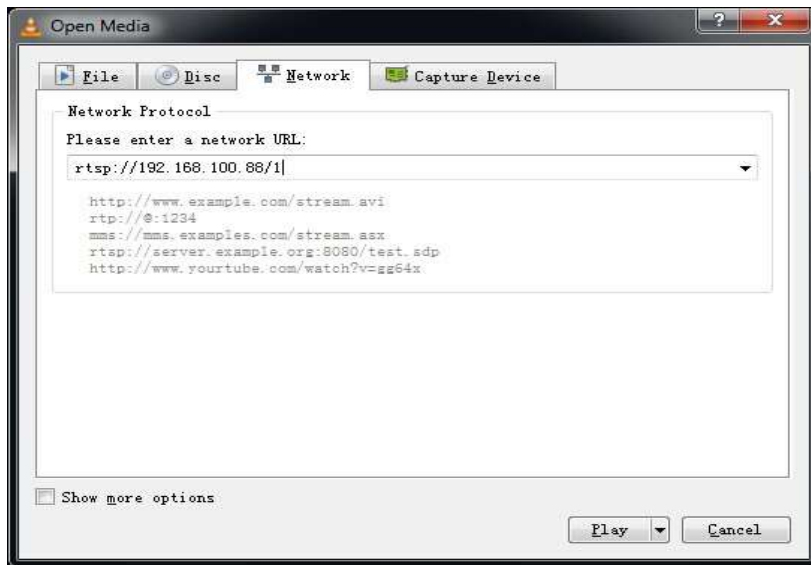

## IP Camera Parameter Setup

### 1 Homepage introduction

#### 1.1 Home Page

All pages include 2 areas:

On the left is the menu and camera control

On the right is real time monitoring - displaying video image and the Parameter settings

#### 1.2 Video viewing window

Click “**Live**” in the menu area. The video viewing window will be resized based upon video resolution, the higher the resolution is, the bigger the playing area is. Double click the viewing window and it will show in full-screen. Double click again and it will return to the initial size.

The Status bar in the viewing window is as shown below:



- 1) Video playback/pause button: controls real-time video. Pause to freeze the image, play to return to live video.
- 2) Audio control buttons: Mute and Volume controls for audio input on camera, if being used.
- 3) Full screen button will switch between Full Screen and Windowed view.



### 1.3 PTZ Control



- 1) Pan and Tilt control: Up, Down, Left and Right arrows and the home button allow you to manual drive the camera to the desired position.
- 2) Zoom: Zoom in and Zoom out buttons allow for wide or narrow (tele) views of the space.
- 3) Focus: Focus In and Focus Out buttons allow for fine manual focus adjustment if the camera has any problems autofocusing on a difficult object.
- 4) PTZ Speeds: Tilt speed can be set at any rate between 1 - 24, Pan speed can be set at any rate between 1 - 20. Zoom and Focus speeds can be set at any rate between 0 – 7.
- 5) PTZ Presets: After manually setting up a shot that you would like to return to later, you can save presets for quick recall of these positions. Type a number between 0 and 254 into the Preset box. Click the "Set" button to save the current location with that preset number. Click the "Call" button to cause the camera to return to that position. This enables smooth, quick and convenient control without the need to manually drive the camera.

#### 1.4 Language selection

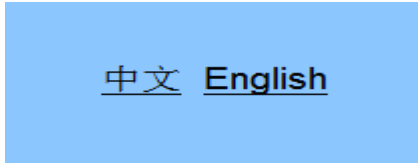

Click either “Chinese” or “English” to change the language of the menu.

### 1 Media

#### 1.1 Video Setup

Click "Video". The streaming parameters may now be set in the right side area. The camera can send 2 simultaneous streams. For example, one in HD and one in SD so that both PCs and phones may have their own stream resolution.

**Video settings**

Video format:

Video Coding:

**First stream**

Resolution:

Bit rate:  kbps (32-8192)

Maximum frame rate:  fps

I key frame interval:  (2-150)

Bit rate control:  CBR  VBR

Fuctuate level:

**Second stream**

Resolution:

Bit rate:  kbps (32-6144)

Maximum frame rate:  fps

I key frame interval:  (2-150)

Bit rate control:  CBR  VBR

Fuctuate level:

**1) Video Settings**

**Video format**

Supports 50HZ(PAL) and 60HZ(NTSC) and Dial Priority (see rotary dial on camera) formats. 60Hz is used for North America.

**Video Coding**

Support both “baseline” and “mainprofile” formats for H.264 video encoding. Baseline is typically used for video conferencing.

**2) First Stream**

**Resolution**

Set the desired video stream resolution. The first stream allows 1920x1080 (1080p) or 1280x720 (720p). The second stream allows 640x360 or 320x180. Higher resolutions will consume more bandwidth.

**Bit Rate**

Users can assign the bit rate of the stream (from 32 – 6144 kbps). Higher bit rates will provide for a higher quality image, if your network bandwidth is sufficient to support the rate.

**Maximum frame rate:**

Users can specify the maximum frame rate (fps or frames per second). Higher frame rates provide smoother video but require higher bit rate settings.

**I key frame interval:**

Affects the quality of the video compression. This setting defines how many predicted frames will be used for each actual frame (from 2-150). Shorter intervals increase video quality at the cost of requiring higher bit rates in order to look good.

**Bit Rate Control method:**

Constant bit rate: video encoder will encode at a constant rate as set in bitrate setting

Variable bit rate: video encoder will encode at a variable rate with maximum as set in bit rate setting, allowing for low motion scenes to use less bandwidth.

**Fluctuate level**

This setting affects how aggressive variable bit rate adjustments will be (1-6). Spikes that are too large may affect video quality. Low levels will not save on as much bandwidth.

**3) Second Stream** (See parameters for first stream).

## 1.2 Image Setup

Click “Image”. The image parameters may now be set in the right side area.

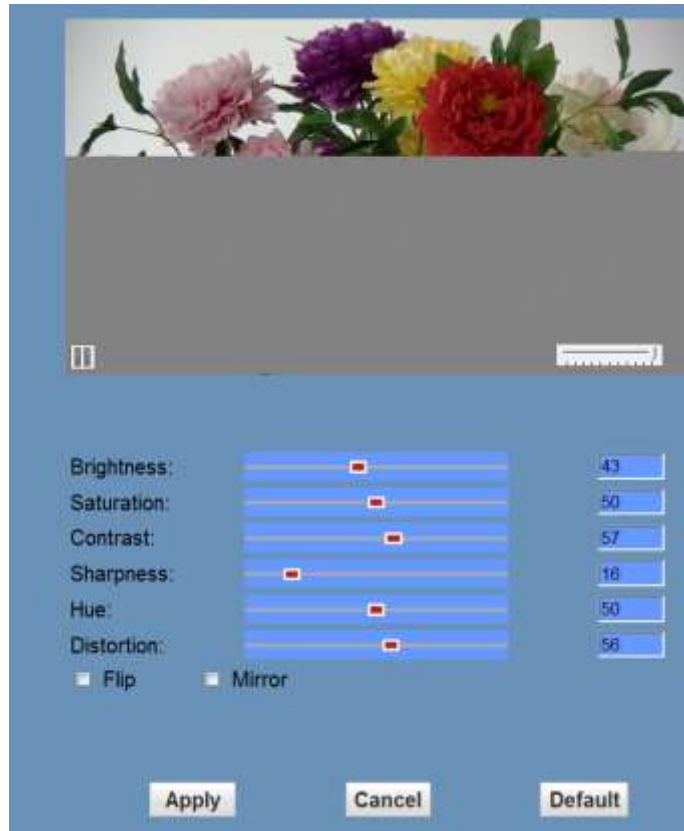

### Brightness

Image brightness 0-100. Use the slider control. The box on the right shows the corresponding numerical value. The Default setting is 43.

### Saturation

Color Saturation 0-100. Use the slider control. The box on the right shows the corresponding numerical value. The Default setting is 50.

### Contrast

Contrast 0-100. Use the slider control. The box on the right shows the corresponding numerical value. The Default setting is 57.

### Sharpness



Sharpness 0-100. Use the slider control. The box on the right shows the corresponding numerical value. The Default setting is 16.

**Hue**

Hue 0-100. Use the slider control. The box on the right shows the corresponding numerical value. The Default setting is 50.

**Distortion**

Adjusts the wide-angle-lens image distortion 0- 100. Use the slider control. The box on the right shows the corresponding numerical value. The Default setting is 0.

**Flip & Mirror**

Check the “Flip” box to invert the image vertically for a ceiling mount. Check the “Mirror” box to invert the image horizontally. The default setting is unchecked.

**Apply, Cancel and Default Buttons**

After adjusting the parameters, press the "Apply" button to save settings. Press the "Cancel" button to cancel the adjustment of the parameters. Press the "Default" button to return to the default value.

**1.3 Audio Setup**

Click “Audio”. The audio parameters may now be set in the right side area.

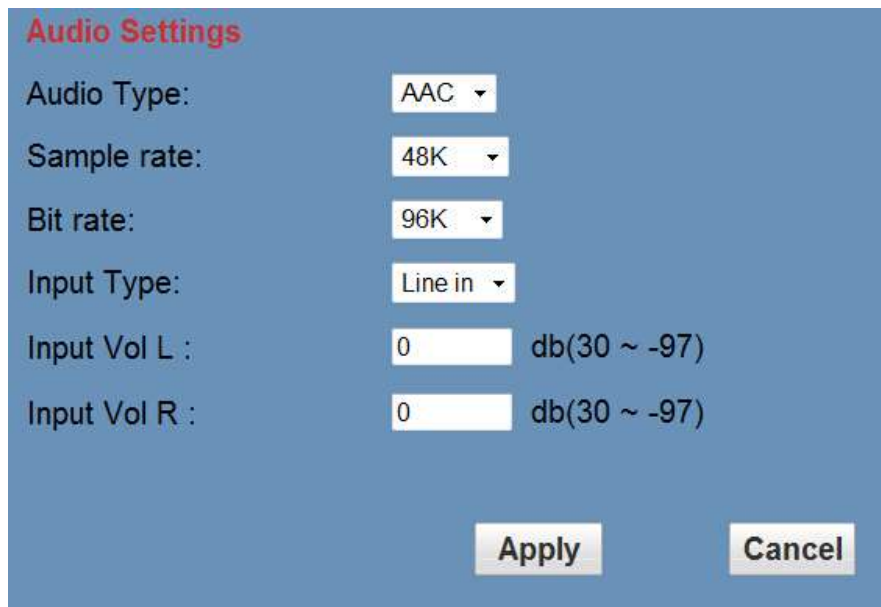

The screenshot shows a blue-themed 'Audio Settings' window. It contains the following controls:

- Audio Type: AAC (dropdown)
- Sample rate: 48K (dropdown)
- Bit rate: 96K (dropdown)
- Input Type: Line in (dropdown)
- Input Vol L: 0 (slider) db(30 ~ -97)
- Input Vol R: 0 (slider) db(30 ~ -97)

At the bottom right, there are 'Apply' and 'Cancel' buttons.

**Audio Type:** AAC is the only audio format currently supported.

**Sample rate:** Selectable as either 44.1 K and 48 K.

**Bit rate:** Selectable among 96k, 128k or 256k

**Input Type:** Currently Line in only

**Input VolL:** Sets the volume of the left audio channel (from -97 to +30dB)

**Input VolR:** Sets the volume of the right audio channel (from -97 to +30dB)

**Apply and Cancel Buttons**

After modifying the parameters, press the "Apply" button to save. Press the "Cancel" button to leave settings unchanged.

### 1.4 System Settings

Click "System". The system parameters may now be set in the right side area.

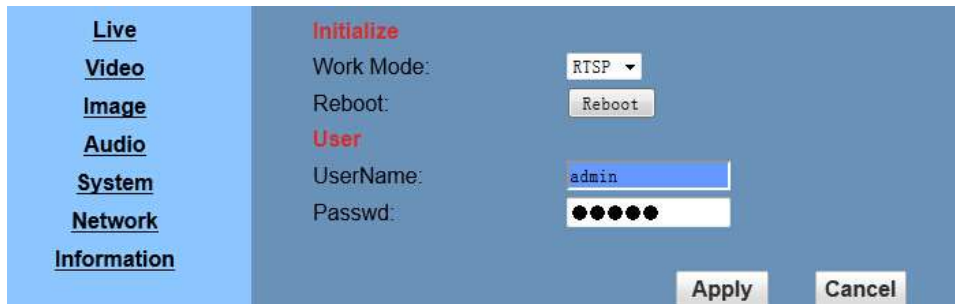

1) **Initialize**

**Work Mode:** RTSP (Real Time Streaming Protocol) is the only streaming protocol currently supported.

**Reboot:** Click the "Reboot" button to initiate a system restart. This is required after changing some settings.

2) **User**

**User and Password:** The user can modify the password (letters and Numbers only).

The default settings are Username: **admin** and Password: **admin**

**Apply and Cancel Buttons**

After modifying the parameters, press the "Apply" button to save. Press the "Cancel" button to leave settings unchanged.

## 1.5 Network Settings

Click “Network”. The network parameters may now be set in the right side area.

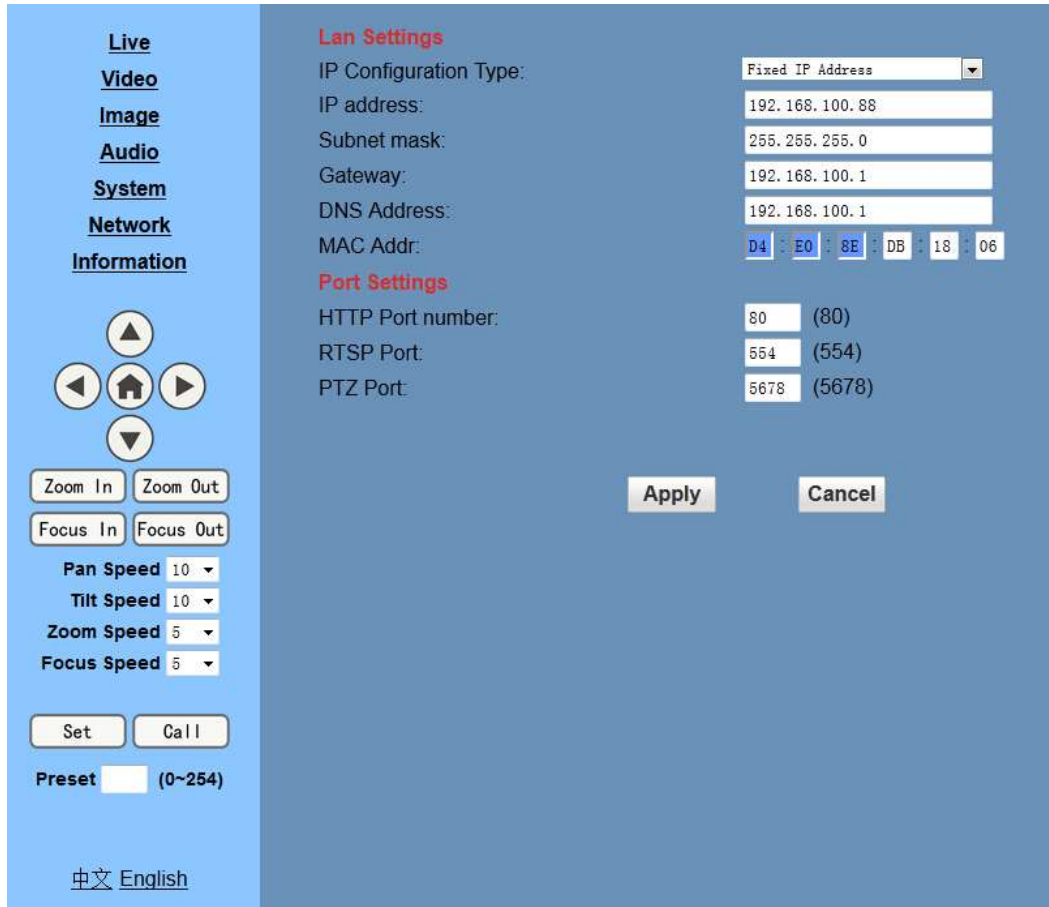

The screenshot shows the PTZ Optics web interface for network configuration. On the left is a navigation menu with options: Live, Video, Image, Audio, System, Network (selected), and Information. Below the menu are navigation buttons (up, down, left, right, home) and camera control buttons (Zoom In, Zoom Out, Focus In, Focus Out). There are also speed settings for Pan, Tilt, Zoom, and Focus, along with Set, Call, and Preset (0-254) buttons. At the bottom left, there are language options: 中文 and English.

The main content area is titled "Lan Settings" and includes the following fields:

- IP Configuration Type: Fixed IP Address (dropdown)
- IP address: 192.168.100.88
- Subnet mask: 255.255.255.0
- Gateway: 192.168.100.1
- DNS Address: 192.168.100.1
- MAC Addr: D4 : E0 : 8E : DB : 18 : 06

Below these are "Port Settings":

- HTTP Port number: 80 (80)
- RTSP Port: 554 (554)
- PTZ Port: 5678 (5678)

At the bottom right of the settings area are "Apply" and "Cancel" buttons.

### 1) LAN Settings

IP settings for the device can be set here. The Default the IP address of the camera is 192.168.100.88. The MAC address can be modified but should be left as set by the factory. Please note that after changing the IP settings for the camera, you may not be able to reconnect until your PC is set for and connected to the same subnet or visible via proper network routing.

## 2) Port Settings

While the IP address identifies the device, the camera uses multiple ports.

**HTTP Port:** This is the port for the web application (the default http port: 80)

**RTSP Port:** The camera supports the RTSP streaming protocol. The default port: 554.

**PTZ Port:** Supports camera control via the TCP protocol. The default port: 5678.

### Apply and Cancel Buttons

After modifying the parameters, press the "Apply" button to save. Press the "Cancel" button to leave settings unchanged.

## 1.6 Device Information

Click "Information"

Shows the current device information, as shown below. You may change the device ID as required for your application.

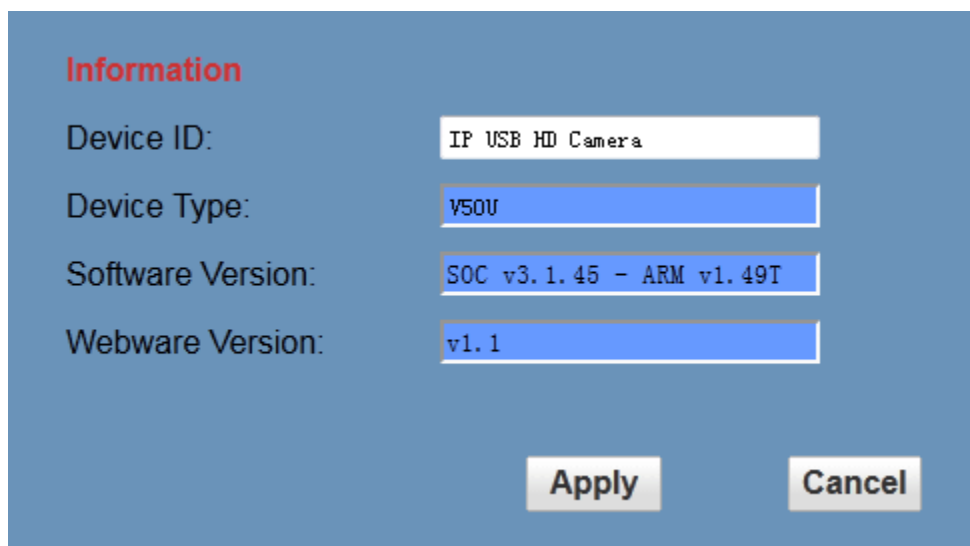

**Information**

Device ID:	<input type="text" value="IP USB HD Camera"/>
Device Type:	<input type="text" value="V50U"/>
Software Version:	<input type="text" value="SOC v3.1.45 - ARM v1.49T"/>
Webware Version:	<input type="text" value="v1.1"/>

## Network Camera Control Protocol

### 1. Setup camera for IP (first see “Setting up the Camera’s IP” section above)

#### Control Notes:

PTZ over TCP/UDP:

The camera currently supports various PTZ control methods, including RS232, RS485, IR remote control, web interface, HTTP-CGI and TCP /UDP protocol.

The camera includes an internal TCP server. The default port number is 5678. When client and server set up a TCP connection, the client sends PTZ command to the internal server and the server will then parse and execute the PTZ commands.

The camera includes an internal UDP server. The default port number is 1259. When client and server set up a UDP connection, the client sends PTZ command to the internal server and the server will then parse and execute the PTZ commands

#### The PTZ command format is based on the VISCA protocol as shown below:

The command presentation format used below is:

##### Control Command Group

Command Function Command Packet Note

Command Function Command Packet Note

...

##### CAM\_Zoom

Stop 8x 01 04 07 00 FF

Tele(Standard) 8x 01 04 07 02 FF

Wide(Standard) 8x 01 04 07 03 FF

Tele(Variable) 8x 01 04 07 2p FF

p = 0(low) - 7(high)

Wide(Variable) 8x 01 04 07 3p FF

Direct 8x 01 04 47 0p 0q 0r 0s FF pqrs: Zoom Position

##### CAM\_Focus

Stop 8x 01 04 08 00 FF

Far(Standard) 8x 01 04 08 02 FF

Near(Standard) 8x 01 04 08 03 FF

Far(Variable) 8x 01 04 08 2p FF



p = 0(low) - 7(high)

Near(Variable) 8x 01 04 08 3p FF

Auto Focus 8x 01 04 38 02 FF

AF On/Off Manual Focus 8x 01 04 38 03 FF

Auto/Manual 8x 01 04 38 10 FF

Direct 8x 01 04 48 0p 0q 0r 0s FF pqrs: Focus Position

### Pan Tilt Drive

Up 8x 01 06 01 VV WW 03 01 FF

VV: Pan speed 0x01 (low speed) to 0x18  
(high speed)

WW: Tilt speed 0x01 (low speed) to 0x14  
(high speed)

YYYY: Pan Position

ZZZZ: Tilt Position

Down 8x 01 06 01 VV WW 03 02 FF

Left 8x 01 06 01 VV WW 01 03 FF

Right 8x 01 06 01 VV WW 02 03 FF

Upleft 8x 01 06 01 VV WW 01 01 FF

Upright 8x 01 06 01 VV WW 02 01 FF

DownLeft 8x 01 06 01 VV WW 01 02 FF

DownRight 8x 01 06 01 VV WW 02 02 FF

Stop 8x 01 06 01 VV WW 03 03 FF

AbsolutePosition

8x 01 06 02 VV WW

0Y 0Y 0Y 0Y 0Z 0Z 0Z 0Z FF

RelativePosition

8x 01 06 03 VV WW

0Y 0Y 0Y 0Y 0Z 0Z 0Z 0Z FF

Home 8x 01 06 04 FF

### CAM\_Memory

Reset 8x 01 04 3F 00 pp FF

pp: Memory Number(=0 to 254) Set 8x 01 04 3F 01 pp FF

Recall 8x 01 04 3F 02 pp FF

### Inquiry Commands

Presentation Format: Command-Type Command-Packet Packet-Comments

CAM\_ZoomPosInq 8x 09 04 47 FF y0 50 0p 0q 0r 0s FF pqrs: Zoom Position

CAM\_FocusPosInq 8x 09 04 48 FF y0 50 0p 0q 0r 0s FF pqrs: Focus Position

Pan-tiltPosInq 8x 09 06 12 FF y0 50 0w 0x 0y 0z 0z 0z 0z FF wwwwww: Pan Position zzzz: Tilt Position

Note: The [x] in the above table is the camera address, [y] = [x + 8]

**HTTP CGI Method:** The camera's integrated web server supports HTTP CGI for PTZ control.

**Pan and Tilt control URL format as below:**

[http://\[Camera IP\]/cgi-bin/ptzctrl.cgi?ptzcmd&\[action\]&\[pan speed\]&\[tilt speed\]](http://[Camera IP]/cgi-bin/ptzctrl.cgi?ptzcmd&[action]&[pan speed]&[tilt speed])

**Parameter Descriptions:**

[Camera IP]: camera IP address;

[action] including: up, down, left, right, ptzstop;

[pan speed] : 1(low speed) – 24(high speed);

[tilt speed]: 1(low speed) – 20(high speed).

Zoom control URLformat as below:

[http://\[Camera IP\]/cgi-bin/ptzctrl.cgi?ptzcmd&\[action\]&\[zoom speed\]](http://[Camera IP]/cgi-bin/ptzctrl.cgi?ptzcmd&[action]&[zoom speed])

[action] including: zoomin, zoomout, zoomstop;

[zoom speed]: 0(low speed) – 7(high speed)。

Focus control URLformat as below:

[http://\[Camera IP\]/cgi-bin/ptzctrl.cgi?ptzcmd&\[action\]&\[focus speed\]](http://[Camera IP]/cgi-bin/ptzctrl.cgi?ptzcmd&[action]&[focus speed])

[action] including: focusin, focusout, focusstop;

[focus speed]: 0(low speed) – 7(high speed)

Preset Position control URL format as below:

[http://\[Camera IP\]/cgi-bin/ptzctrl.cgi?ptzcmd&\[action\]&\[position number\]](http://[Camera IP]/cgi-bin/ptzctrl.cgi?ptzcmd&[action]&[position number])

[action] including: posset, poscall;

[position number]: 0-89, 100-254PTZ ON IP NETWORK

**TCP Protocol Method:** The camera's integrated web server supports TCP for PTZ control.

The camera has an internal TCP server. There is a port configured for receiving the connection from a TCP client. The default TCP port number is 5678. When client and server initiate a TCP connection, the client sends PTZ command to the internal server and the server will then parse and execute the PTZ commands.

PTZ command format is based on VISCA Protocol to define, details as below:

Command	Function	Command Packet	Comments
Zoom	Stop	81 01 04 07 00 FF	
	Tele(Standard)	81 01 04 07 02 FF	
	Wide(Standard)	81 01 04 07 03 FF	
	Tele(Variable)	81 01 04 07 2P FF	P = 0(low speed) - 7(high speed)
	Wide(Variable)	81 01 04 07 3P FF	
Focus	Stop	81 01 04 08 00 FF	
	Far(Standard)	81 01 04 08 02 FF	
	Near(Standard)	81 01 04 08 03 FF	
	Far(Variable)	81 01 04 08 2P FF	P = 0(low speed) - 7(high speed)
	Near(Variable)	81 01 04 08 3P FF	
	Auto Focus	81 01 04 38 02 FF	
	Manual Focus	81 01 04 38 03 FF	AF On/Off
	Auto/Manual	81 01 04 38 10 FF	
Pan & tilt	Up	81 01 06 01 VV WW 03 01 FF	VV: Pan speed 0x01 (low speed) to 0x18 (high speed) WW: Tilt speed 0x01 (low speed) to 0x14 (high speed)
	Down	81 01 06 01 VV WW 03 02 FF	
	Left	81 01 06 01 VV WW 01 03 FF	
	Right	81 01 06 01 VV WW 02 03 FF	
	UpLeft	81 01 06 01 VV WW 01 01 FF	
	UpRight	81 01 06 01 VV WW 02 01 FF	
	DownLeft	81 01 06 01 VV WW 01 02 FF	
	DownRight	81 01 06 01 VV WW 02 02 FF	
	Stop	81 01 06 01 VV WW 03 03 FF	
	Home	81 01 06 04 FF	
Preset position	Reset	81 01 04 3F 00 PP FF	PP: Position Number(==0x00-0x59, 0x64-0xFE)
	Set	81 01 04 3F 01 PP FF	
	Recall	81 01 04 3F 02 PP FF	

### **Pan and Tilt**

Control URL format as below:

*http://[Camera IP]/cgi-bin/ptzctrl.cgi?ptzcmd&[action]&[pan speed]&[tilt speed]*

[Camera IP]: This camera's IP address;

[action] including: up, down, left, right, ptzstop;

[pan speed] : 1(low speed) – 24(high speed);

[tilt speed]: 1(low speed) – 20(high speed).

### **Zoom**

Control URL format as below:

*http://[Camera IP]/cgi-bin/ptzctrl.cgi?ptzcmd&[action]&[zoom speed]*

[Camera IP]: This camera's IP address;

[action] including: zoomin, zoomout, zoomstop;

[zoom speed]: 0(low speed) – 7(high speed).

### **Focus**

Control URL format as below:

*http://[Camera IP]/cgi-bin/ptzctrl.cgi?ptzcmd&[action]&[focus speed]*

[Camera IP]: This camera's IP address;

[action] including: focusin, focusout, focusstop;

[focus speed]: 0(low speed) – 7(high speed)

### **Preset Position**

Control URL format as below:

*http://[Camera IP]/cgi-bin/ptzctrl.cgi?ptzcmd&[action]&[position number]*

[Camera IP]: This camera's IP address;

[action] including: posset, poscall;

[position number]: 0-89,100-254.

## USB Control of Camera

Connect a USB 3.0 cable from the camera to a computer's USB3.0 port.

Install the software downloaded from:

[http://huddlecamed.com/wp-content/uploads/2014/04/AMCAP-USB-Camera-Configuration-Software.exe\\_.zip](http://huddlecamed.com/wp-content/uploads/2014/04/AMCAP-USB-Camera-Configuration-Software.exe_.zip)

(amcap.exe)  amcap.exe and double click the .exe to start the program (there is no installation required).

From the *Options* Menu choose the *Video Capture Filter* command. Use the camera controls to control the camera.

Some early releases of the camera model may not support UVC control (control over USB).

Conferencing and other software that has integrated UVC Control functionality will be able to also control the camera via USB.

## Maintenance and Troubleshooting

### Camera Maintenance

- If the camera will not be used for a long time, please turn off the power switch.
- Use a soft cloth or lotion-free tissue to clean the camera body.
- Use a soft dry lint-free cloth to clean the lens. If the camera is very dirty, clean it with a diluted neutral detergent. Do not use any type of solvent or harsh detergent, which may damages the surface.

### Unqualified Applications

- Do not shoot extremely bright objects for a long period of time, such as sunlight, ultra-bright light sources, etc...
- Do not operate in unstable lighting conditions, otherwise the image may flicker.
- Do not operate close to powerful electromagnetic radiation, such as TV or radio transmitters, etc...

### Troubleshooting

- No image
  1. Check whether the power cord is connected, voltage is OK, POWER lamp is lit.
  2. Check whether the camera can "self-test" after startup (camera will do a brief pan-tilt tour and return to the home position, or if preset 0 is set, the camera will return to the preset 0 position).
  3. Check the BOTTOM dip switch and make sure the two dip switches are both set OFF. These switches are not used in operating mode.
  4. Check that the signal cable is connected correctly (HDMI or USB3.0 depending upon your application).



1. If HDMI, make sure that the destination device is accessing the HDMI port that you plugged into.
  2. If USB, make sure that your operating system has properly recognized the device as a video camera and that you have selected it in your application (e.g. conferencing) software as the active video source.
- Abnormal display of image
    1. Check setting of rotary dial on rear of camera. Be sure to use a resolution and refresh rate that is supported by your software.
  - Image is shaky or vibrating.
    1. Check whether camera is mounted solidly or sitting on a steady horizontal and level surface.
    2. Check the building and any supporting furniture for vibration. Ceiling mounts are often affected by building vibration more than wall mounts.
    3. Any external vibration that is affecting the camera will be more apparent when in tele zoom (zoomed in) settings.

## Control

- IR remote controller does not control the camera
  1. Does one of the 4 “Camera Select” buttons (top row of remote) light up when you press any button on the remote?
    1. If not, change the batteries in the remote.
  2. Are the camera and remote set to the same IR address? You can use press \*#1 (3 buttons in sequence) on the remote to set the camera to address 1. Press “Camera Select” 1 on the remote to control the camera.
  3. Try removing other sources of IR interference (e.g. sunlight, fluorescent lighting).
- Serial communication does not control the camera
  1. Make sure the camera is on and functioning with the IR remote control.
  2. Verify that the RS232 cable is connected correctly and using the proper pinout.
  3. Verify the communication settings of the control software or device (e.g. joystick).
  4. Verify that the communication port on the controlling device is activated (e.g. Com port on PC).
  5. Verify that all communication settings in the OSD Setup Menu correlate to the commands being used (e.g. VISCA address).

**Important Notes Regarding USB Connectivity:**

USB 3.0 ports are backwards compatible with USB 2.0 devices. USB 2.0 ports are not completely forward compatible with USB 3.0 devices (some USB 3.0 devices will connect to USB 2.0 with limited functionality).

External USB hubs should be avoided (i.e. give the camera its own USB port on the device) as they are not well suited to transmitting HD video reliably.

USB extension systems must be fully compatible with the version of USB that you are using and must utilize an external power supply, when required. Caution: Some “compatible” USB 3.0 extenders do not actually have the full 5Gbps bandwidth required for uncompressed HD video - so check bandwidth specs. Always connect the HuddleCam directly to the device in order to associate the UVC drivers before attempting to use any extension system.

USB 3.0 power saving settings in the device’s operating system should be turned off completely for reliable USB 3.0 camera connectivity.

**PTZ Optics Cameras**

All PTZ Optics cameras utilize the UVC (USB Video Class) drivers that are built into Windows, Mac OS and Linux to stream HD video to your device via your device’s USB 3.0 port. When your device successfully recognizes the camera, your device will register the PTZ Optics as an “imaging device”.

You can see this in your Windows Device Manager program (type “device manager” into the Windows search tool) as shown in the screenshot, below:

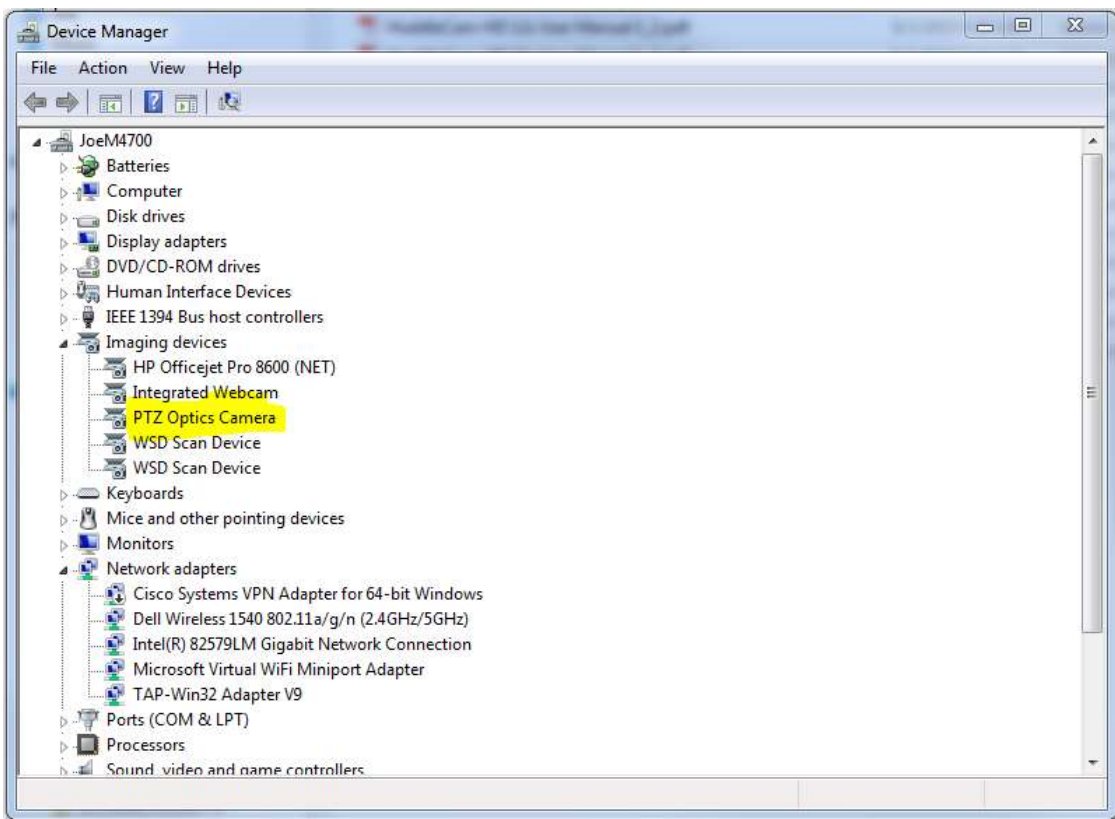

In this example, you can see the PTZ Optics model in use connected as a fully functional USB 3.0 device (PTZ Optics).

If your device has not connected to or has not recognized the PTZ Optics as an imaging device (in which case, you may see a new “unknown device”, “Westbridge” or “CYTFX3” labeled device show up in Device Manager’s “Universal Serial Bus Controllers” section rather than in the “Imaging Devices” section), the PTZ Optics will not be available to programs that utilize a camera. In this case, try restarting the device and reconnecting the camera via USB 3.0.

Similarly, you can see a connected device in System Information on a MAC. See screenshot below:

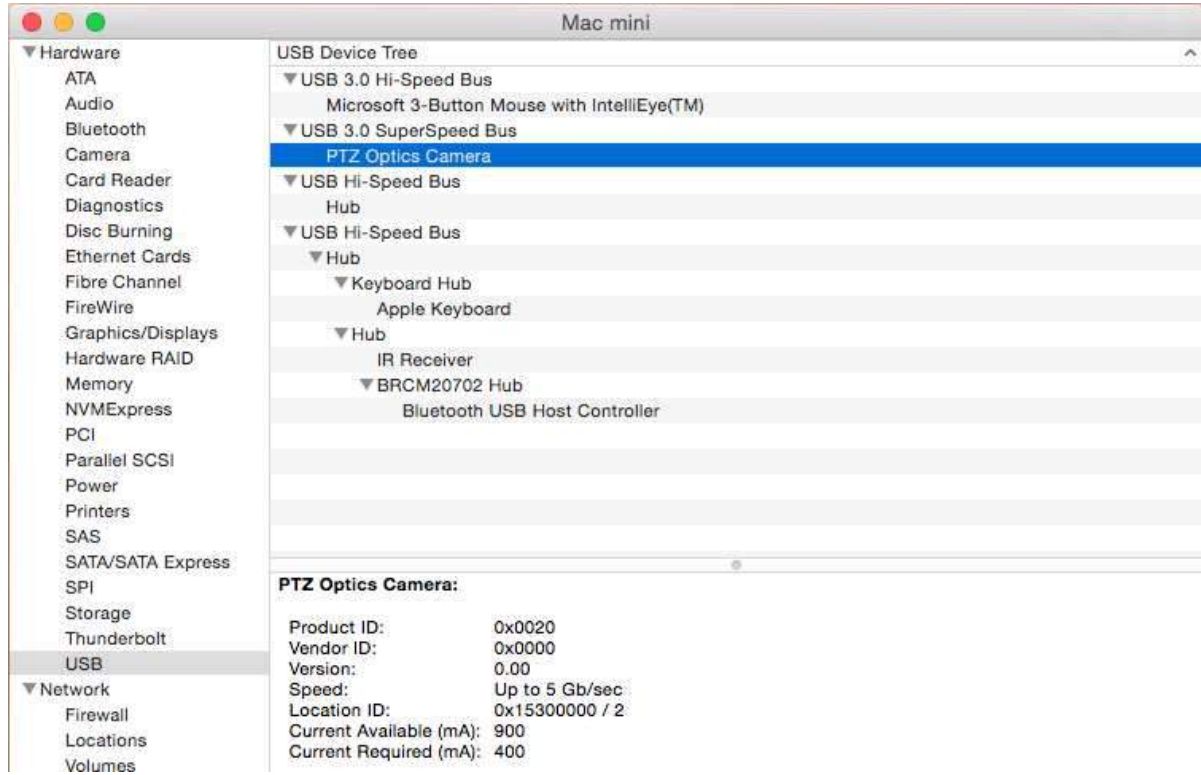

In this example, you can see the PTZ Optics model in use connected as a fully functional USB 3.0 device “PTZ Optics”.

## Copyright Notice

The entire contents of this manual, whose copyright belongs to PTZ Optics, may not be cloned, copied or translated in any way without the explicit permission of the company. Product specifications and information referred to in this document are for reference only and as such are subject to updating at any time without prior notice.